

CS 470 Spring 2024

Mike Lam, Professor

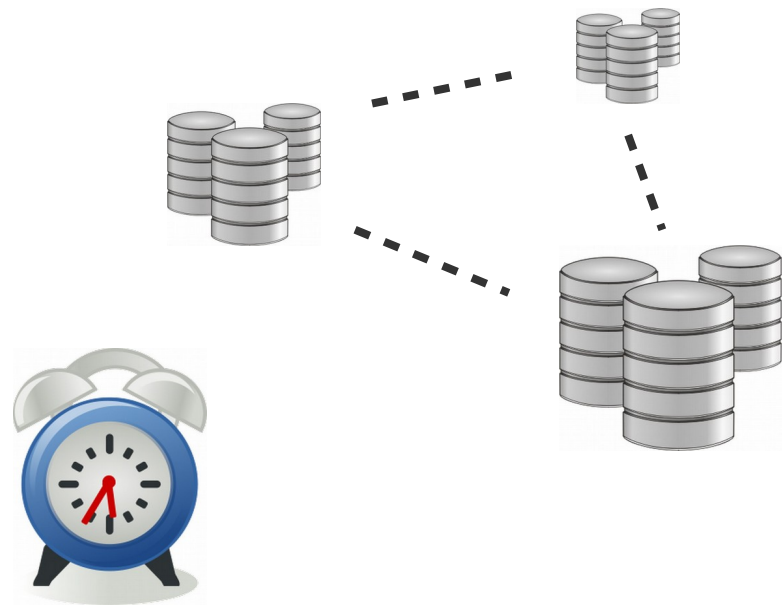

Synchronization and Consistency

Content taken from the following:

"Distributed Systems: Principles and Paradigms" by Andrew S. Tanenbaum and Maarten Van Steen (Chapters 6, 7 and 11)

Various online sources

Synchronization

- In a shared-memory system:
 - Core mechanism: mutual exclusion
 - Conditions, semaphores, and barriers
- In a distributed-memory system:
 - Core mechanism: message passing
 - Coordinated **clocks**
 - **Absolute** vs. **logical**
 - **Election** and **consensus** algorithms
 - **Consistency** models and protocols

Clocks / Timers

- Measuring time
 - Movements of sun, moon, and stars
 - Unwinding of wound spring
 - Quartz crystal oscillating under tension
 - Energy transitions of a caesium 133 atom
- Synchronizing absolute clocks
 - Calendars and leap year/second adjustments
 - Coordinated Universal Time (UTC)
 - Clock skew
 - Network Time Protocol (NTP)

Network Time Protocol

- Reference clocks (hardware-based)
- Stratum 1-15 and 16 (unsynced)
- 64-bit time values (<1 ns resolution)

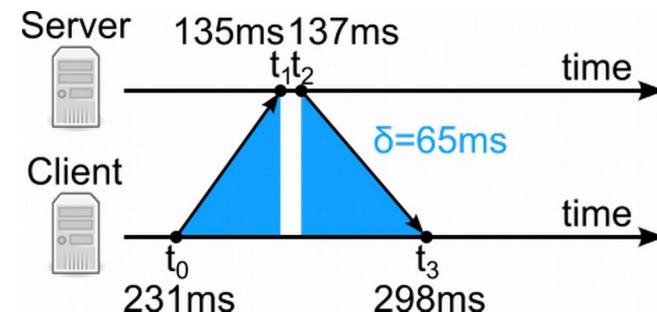
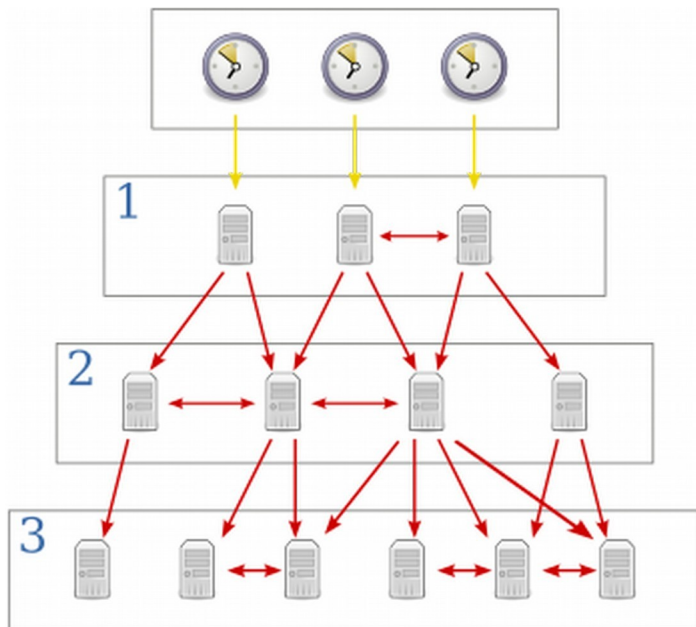

Time offset:

$$\theta = \frac{(t_1 - t_0) + (t_2 - t_3)}{2}$$

Round-trip delay:

$$\delta = (t_3 - t_0) - (t_2 - t_1)$$

Logical clocks

- **Lamport clocks / timestamps**
 - Invented by Leslie Lamport in 1978
 - Core notion: "**happens-before**" (total ordering)
 - Assigns clock value $C(x)$ to any event x
 - Increment local clock before sending
 - Include local clock when sending
 - Adjust local clock after communications
 - Must preserve "happens-before" ordering
 - Always forwards—never backwards!
 - If a happened before b , then $C(a) < C(b)$
 - Converse is not necessarily true!
 - Does not capture any notion of causality

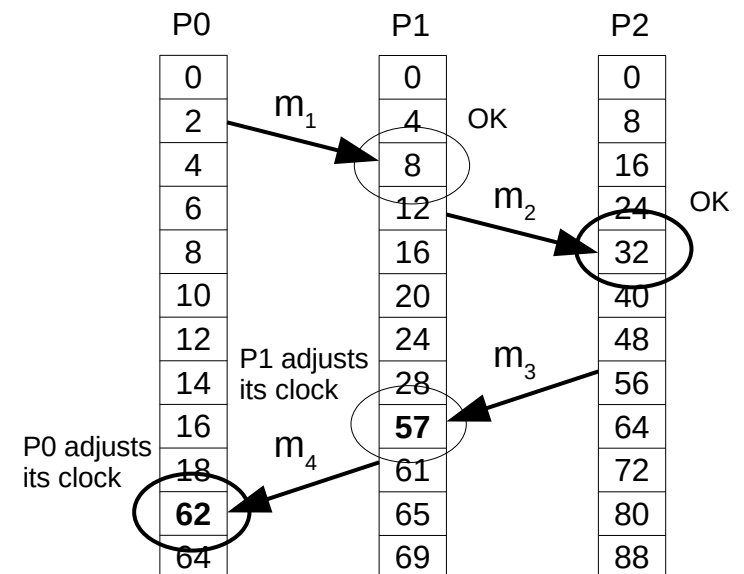
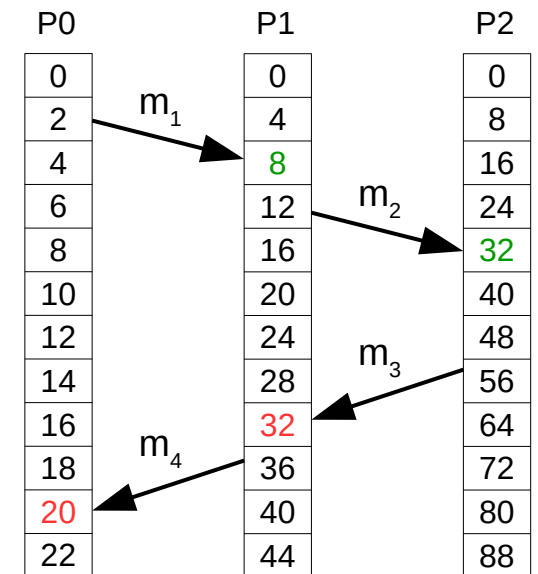

For more info:

<http://dl.acm.org/citation.cfm?id=359563>

Logical clocks

- Which of the following is NOT true of Lamport clocks?
 - A. If a happened before b, then $C(a) < C(b)$
 - B. If b happened before a, then $C(b) < C(a)$
 - C. If $C(a) \geq C(b)$, then a did not happen before b
 - D. If $C(a) < C(b)$, then a happened before b
 - E. All of the above are true

Vector clocks

- **Vector clocks** restore a notion of causality (partial ordering)
 - Keep a vector of clock values instead of only one
 - VC_i is the logical clock at process P_i
 - $VC_i[j] = k$ means that P_i knows that k events have occurred at P_j (i.e., P_i 's knowledge of P_j 's local time), any of which could have causality influence

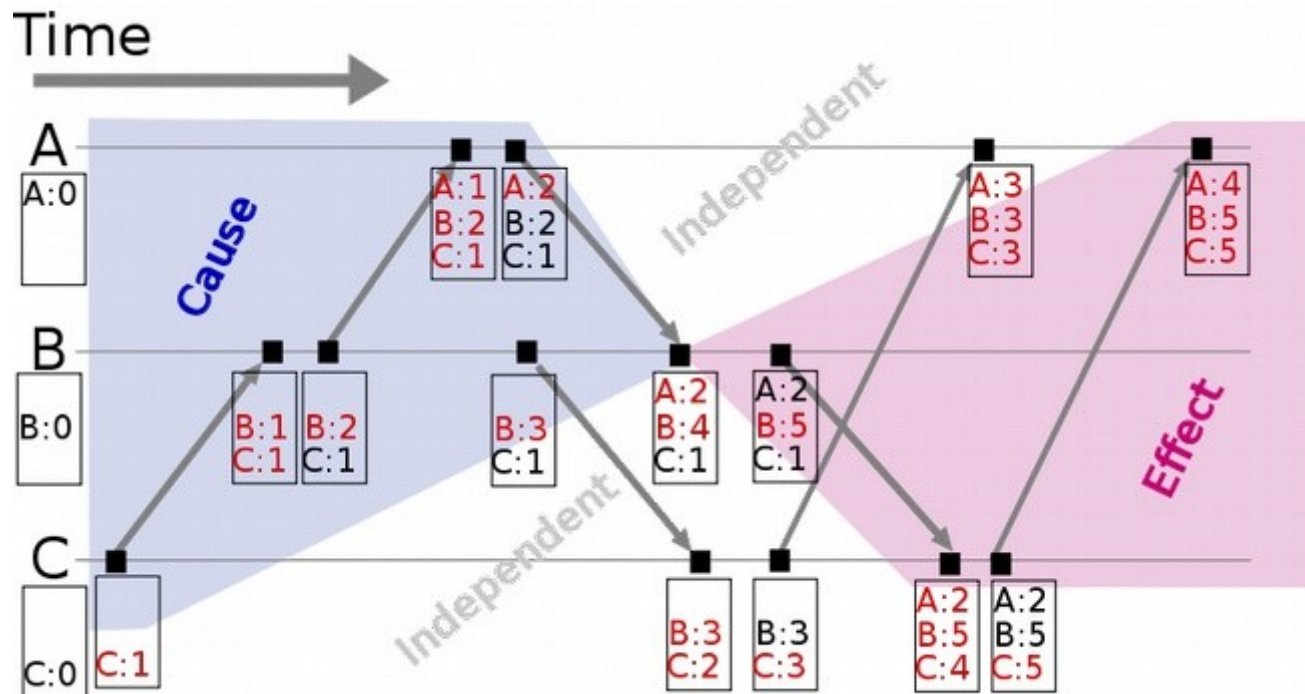

Vector clocks

- If process A has vector clock $\{(A:4), (B:2)\}$ and process B has vector clock $\{(A:4), (B:6)\}$, which of the following is true?
 - A. A has seen all events that B has
 - B. B has seen all events that A has
 - C. A has seen more events in total than B
 - D. B has seen fewer events in total than A
 - E. None of the above are true

Vector clocks

- If process A has vector clock $\{(A:4), (B:2)\}$ and process B has vector clock $\{(A:4), (B:6)\}$, which of the following is true?
 - A. The most recent event on A could have caused an event on B
 - B. The most recent event on B could have caused an event on A
 - C. No event on A could have caused an event on B
 - D. No event on B could have caused an event on A
 - E. None of the above are true

Distributed mutual exclusion

- Clocks provide *time*-based synchronization
- What about *task*-based synchronization?
- How can we implement mutual exclusion in a distributed system?

Distributed mutual exclusion

- **Token**-based (often used in ring networks)
 - Simple; slow; susceptible to lost tokens
- Permission-based
 - **Centralized** (single coordinator)
 - Easy to implement; single bottleneck and point of failure
 - **Decentralized** (multiple coordinators, need majority vote)
 - More resilient; can be slow; possibility of starvation

Election algorithms

- If a coordinator is needed, there are various **election** strategies available to choose one
- **Bully** algorithm
 - Always defer to higher-numbered nodes
- **Ring** algorithm
 - Enforce one-way election traffic
- **Wireless** algorithms
 - Choose the *best* coordinator (e.g., CPU speed, battery life, etc.)

Distributed consensus

- Elections (and related **auctions**) are a specialized form of the general problem of determining **consensus** in a distributed system
- **Paxos** protocol: two-phase rounds
 - **Prepare / promise**: A proposer creates a proposal with value N larger than any value it has previously used and sends it to a quorum of acceptors, who respond with a promise to ignore future proposals with a value less than N
 - **Accept / accepted**: If a proposer receives enough promises, it sets a final value M for its proposal and sends it to a quorum of acceptors, who accept it if M is greater than any other proposals it has promised to
 - Real protocol has multiple ways to handle failures and lack of consensus

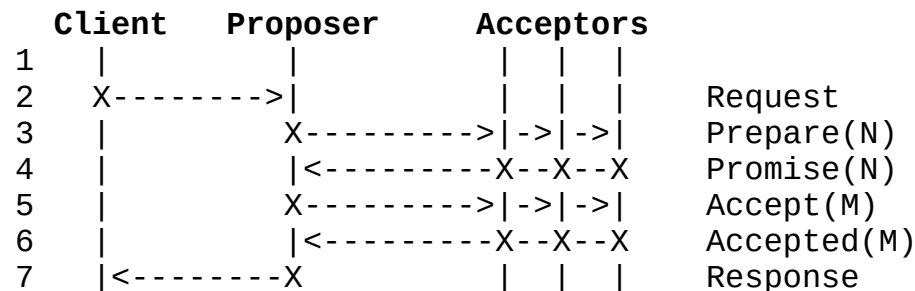

Distributed consensus

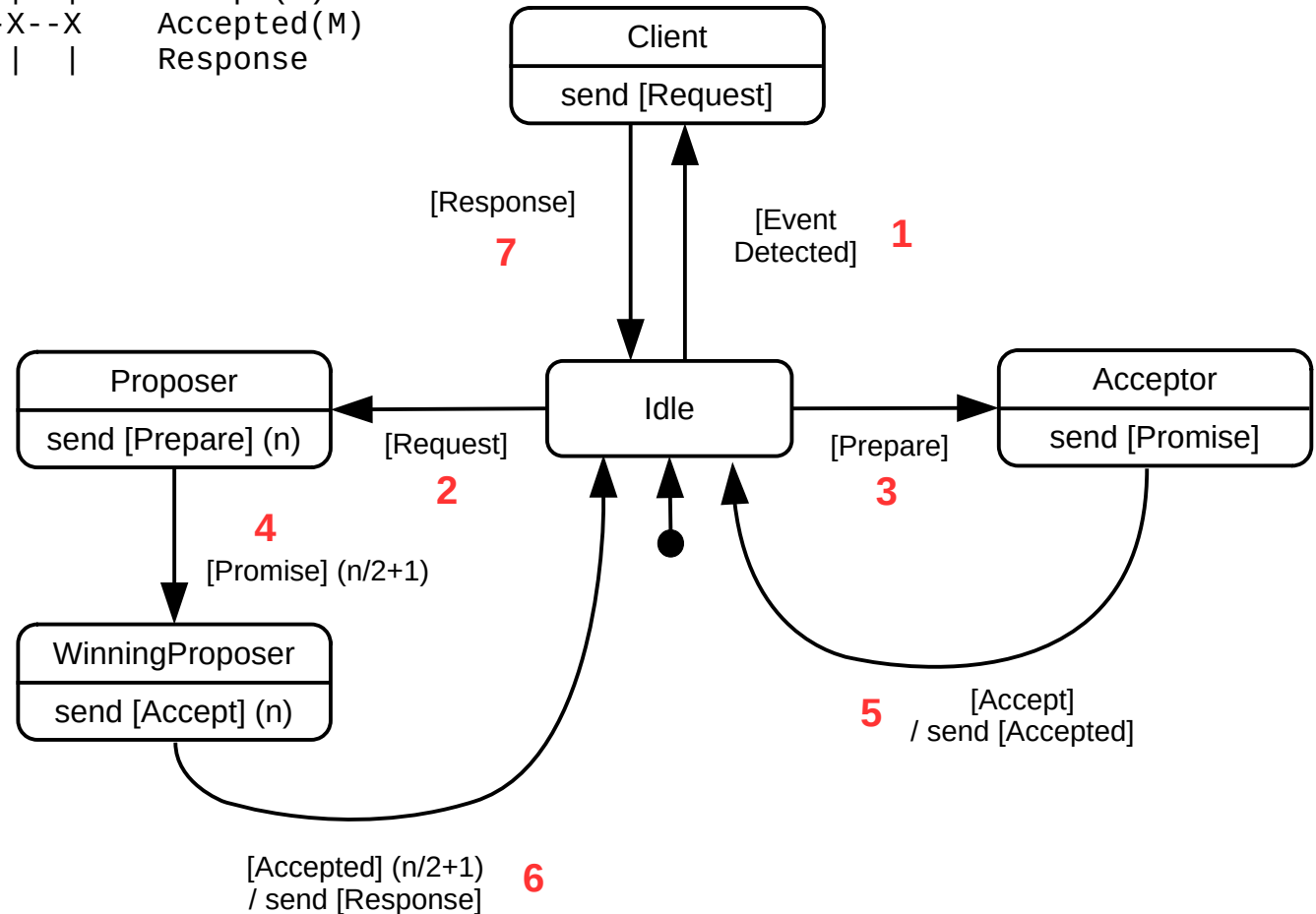
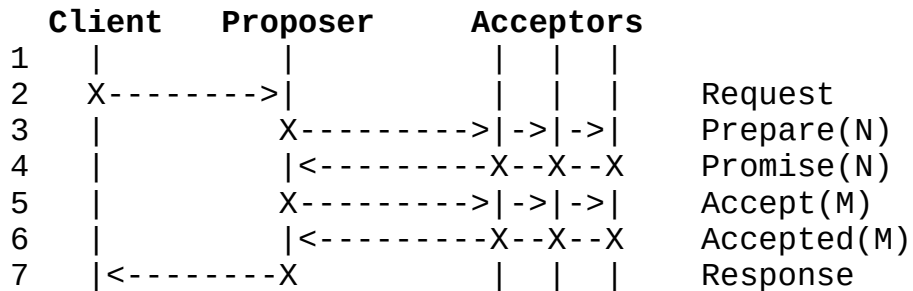

Distributed consensus

- What is the maximum number of unique states (include “idle”) for a single participant during the Paxos protocol?

- A. 1
- B. 2
- C. 3
- D. 4
- E. 5

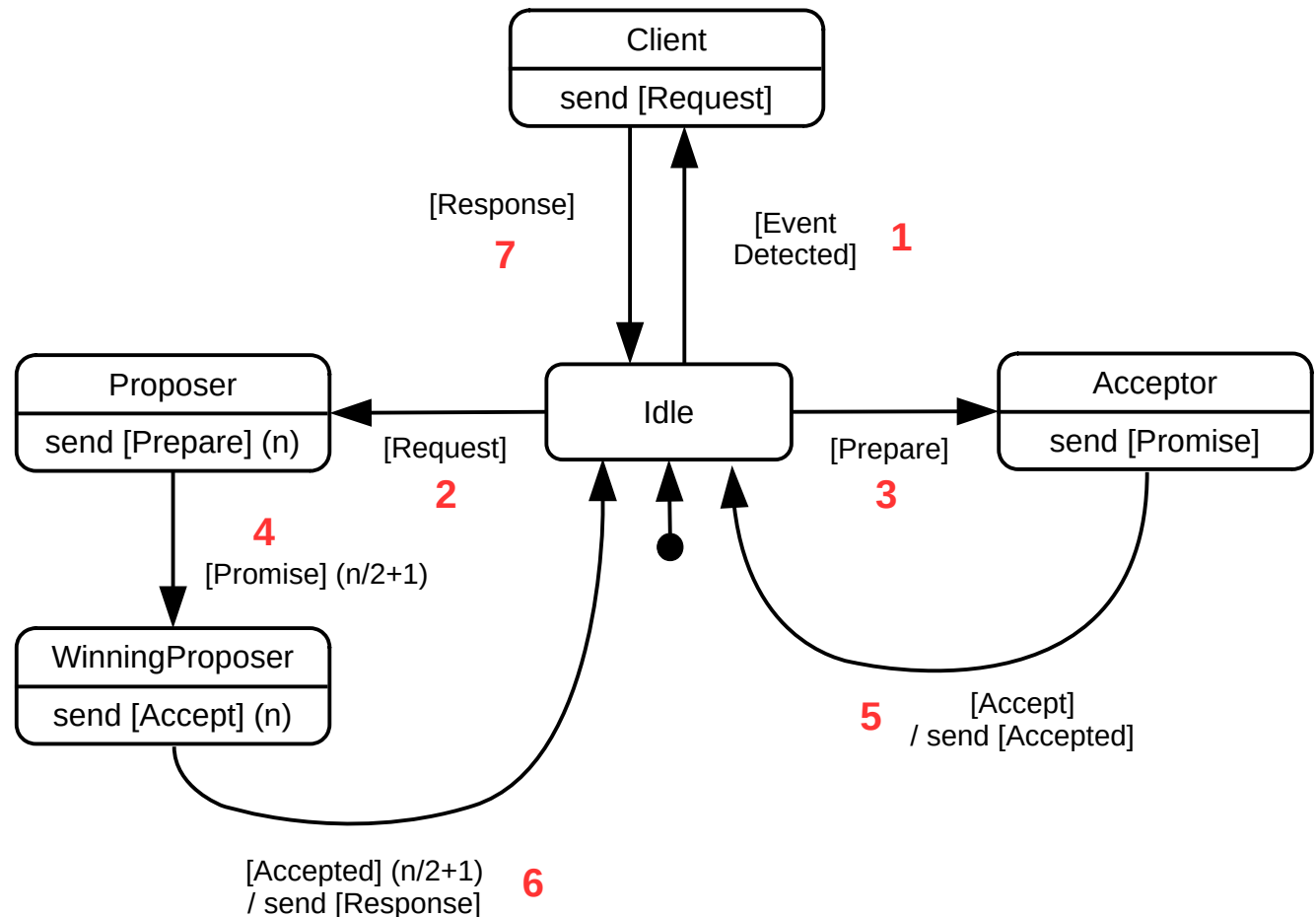

Replication

- All of these protocols require a lot of communication
 - Communication is expensive!
- Alternative: keep redundant data
 - **Replica**: a copy of data
 - In a distributed system, every process could be a separate replica
 - Goal: improved availability/locality and therefore performance
 - Related concepts: **mirroring** and **caching**
 - Relieve single-node access bottlenecks

Replicas

- Server-initiated (e.g., **mirroring**)
 - Updates are **pushed** to other replicas
- Client-initiated (e.g., **caching**)
 - Updates are **pulled** from other replicas
 - **Write-through** vs. **write-back**
- Peer-to-peer
 - Nodes have symmetric roles
 - Requires well-defined protocol for enforcing consistency
- Issue: keeping replicas **consistent**
 - Propagating updates
 - Events (reads/writes) will arrive at different times
 - But maybe we're ok with some inconsistency

Replication and consistency

- Theme: **loosen consistency constraints** to *decrease communication overhead*
 - Tradeoff: performance vs. consistency

Replication and consistency

- CS 374 pop quiz: What does ACID stand for in the context of database consistency?
 - A. Accessible, Continuous, Integral Data
 - B. Atomic, Consistent, Isolated, Durable
 - C. Atomic, Constant, Integrated, Data-agnostic
 - D. Agnostic, Continuous, Isolated, Durable
 - E. Accessible, Consistent, Integrated Database

Replication and consistency

- Theme: **loosen consistency constraints** to *decrease communication overhead*
 - Tradeoff: performance vs. consistency

Traditional databases:

ACID - Atomic, Consistent, Isolated, Durable

Distributed systems:

BASE - Basically Available, Soft-state, Eventually consistent

Replication

- **Consistency model**: contract between entities and data stores
 - If the entities follow the rules, the data store will be consistent
- Data-centric models (global view)
 - **Strict / continuous consistency** (absolute time)
 - **Sequential consistency** (logical time)
 - **Causal consistency** (logical causality)
- Client-centric models (local view)
 - **Monotonic reads**
 - **Monotonic writes**
 - **Read-your-writes**
 - **Writes-follow-reads**

Strict / continuous consistency

- All events are seen instantaneously by all nodes
 - Issue: speed of light ($\sim 3 \times 10^8$ m/s) prevents instantaneous updates, especially in large-scale distributed systems
 - To be practical, designate an interval of allowable deviation

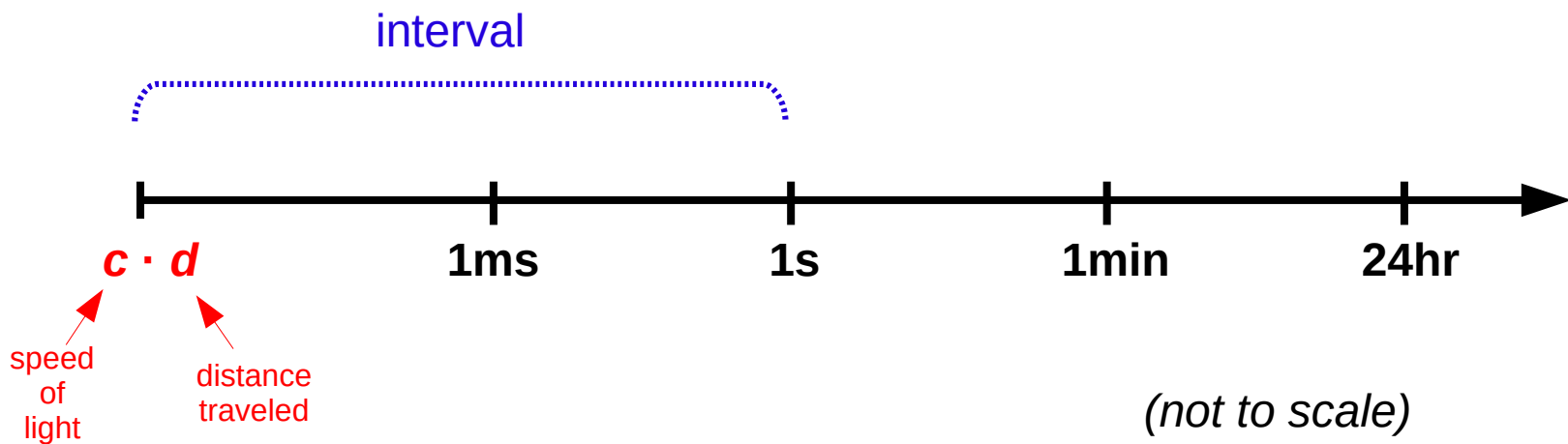

Sequential consistency

- Every node sees events in the same order
 - Events must have a **total order** (i.e., they must be **linearizable**)
 - Important: a particular node need not see ALL events
 - But the order of the ones it sees must not violate the total order
 - Notation: "W(x)a" means "write value a to item x"
 - (corresponding notation for reads)

P0: W(x)a
P1: W(x)b
P2: R(x)b R(x)a
P3: R(x)b R(x)a

Sequentially-consistent

P0: W(x)a
P1: W(x)b
P2: R(x)b R(x)a
P3: R(x)a R(x)b

NOT sequentially-consistent

Causal consistency

- **Causally-related** events must be seen in order
 - Reads are causally-related to corresponding writes
 - Writes are causally-related to previous operations on the same node
 - Can be implemented using vector clocks
 - To verify, build global causality chain and check each process's view

P0: W(x)a
P1: W(x)b
P2: R(x)b R(x)a
P3: R(x)a R(x)b

Causally-consistent

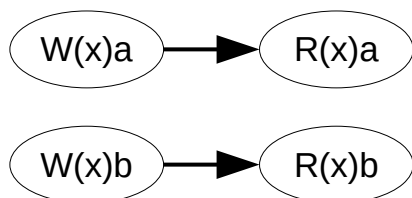

P0: W(x)a
P1: R(x)a W(x)b
P2: R(x)b R(x)a
P3: R(x)a R(x)b

NOT causally-consistent

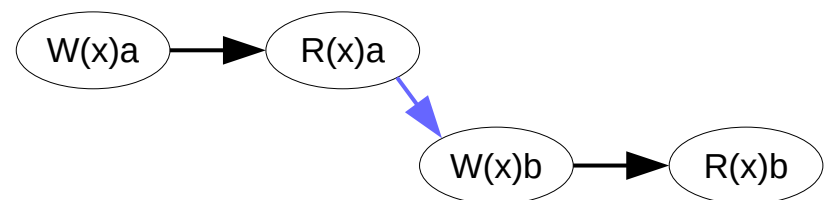

Sequential / causal consistency

- Is this sequence sequentially-consistent, causally-consistent, both, or neither?
 - A. Sequentially-consistent only
 - B. Causally-consistent only
 - C. Both
 - D. Neither

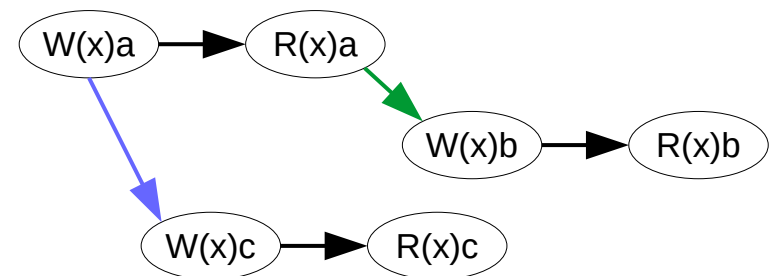
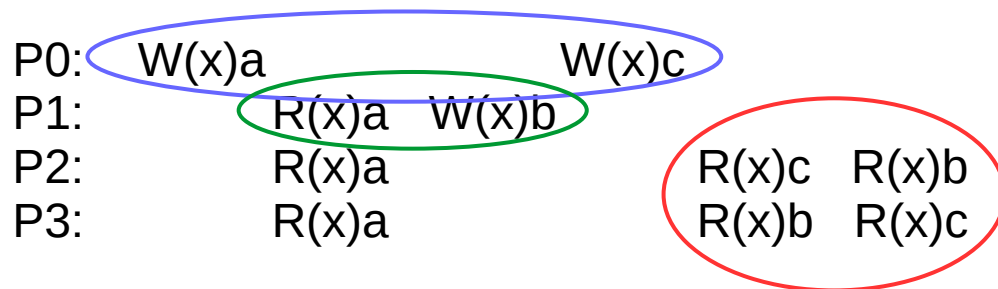

**Causally-consistent, but
NOT sequentially-consistent**

Partial vs. total ordering

- **Ordering**: definition of “<” operator
 - Usually over pairs of entities (for us, messages)
 - **Total ordering**: definition of “<” for **all** pairs (w/ transitivity)
 - Depicted graphically using a line
 - **Partial ordering**: definition of “<” for **some** pairs (also w/ transitivity)
 - Depicted graphically using a **graph** or **lattice**

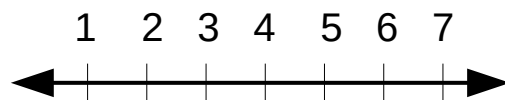

“<” \equiv “less-than”
(total ordering)

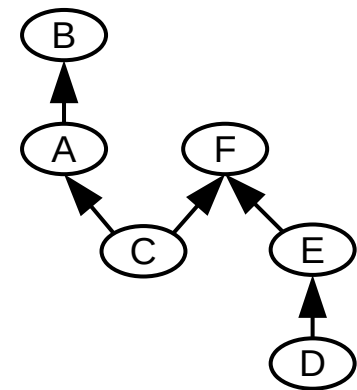
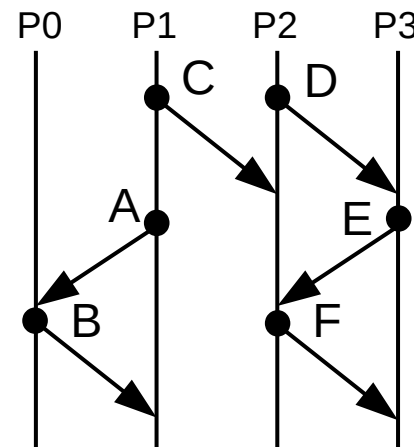

“<” \equiv “happens-before” (partial ordering)

Partial vs. total ordering

- Which of the following is NOT true of the following happens-before relationship?

- A. $D < E$
- B. $D < F$
- C. $D < C$
- D. $C < F$
- E. $C < B$

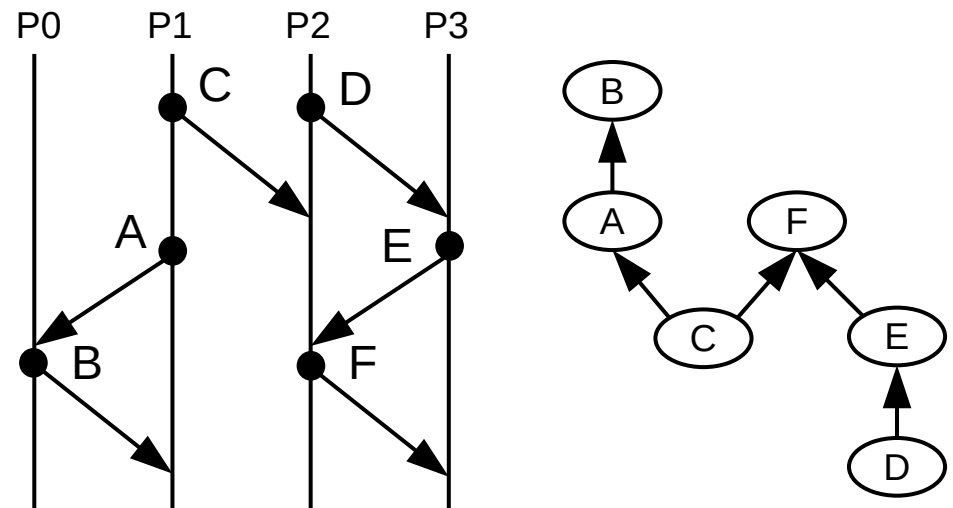

“<” ≡ “happens-before” (partial ordering)

Implication

- Sequential consistency implies causal consistency
 - There is no way for the partial ordering of causal consistency to contradict the total ordering implied by sequential consistency
 - Both properties (writes before reads on same data & strict ordering for events on single processes) used to build the partial ordering are already enforced by any valid total ordering
 - Thus, every sequentially-consistent sequence must also be causally-consistent
 - Colloquially: causal consistency is **looser** than sequential consistency

Client-centric consistency

- Previous models focused on a **global** view of data
 - Sometimes called **data-centric** consistency models
- In a distributed system, we may only be interested in the **local** view at any given node
 - This motivates **client-centric** consistency models

Client-centric consistency

- Original application: **Bayou** database system for mobile computing
 - Developed in mid-1990s
 - Massive number of replicas
 - Multiple networks and unreliable connectivity
 - Data-centric, global consistency models are infeasible
 - Theme: loosen the constraints!
 - **Four** different consistency models (not mutually exclusive)

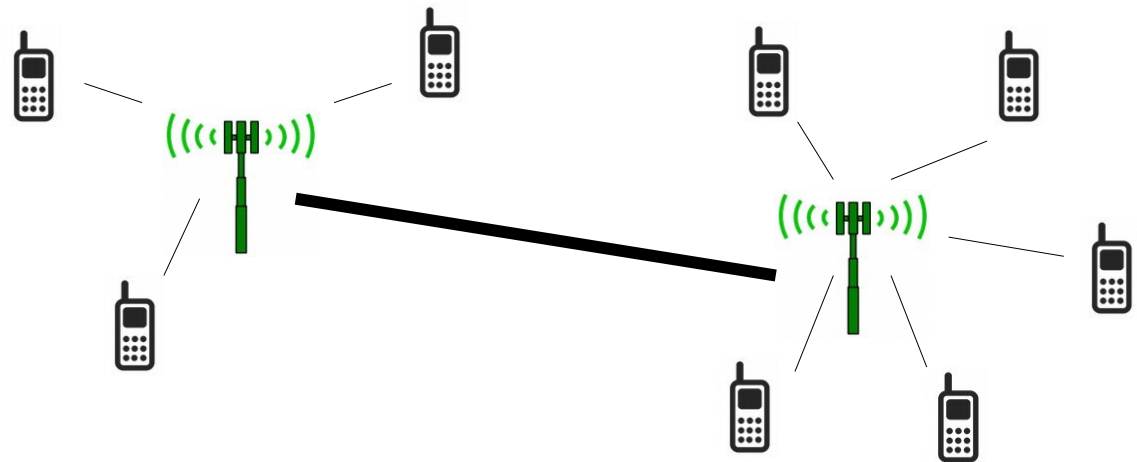

For more info:

<http://dl.acm.org/citation.cfm?id=504497>

Monotonic reads / writes

- **Monotonic reads**: if a process reads X , any successive read to X will see the same value or a more recent one
 - I.e., the process will never see an older version
 - E.g., distributed email database (messages shouldn't disappear when viewing a thread on the same client)
- **Monotonic writes**: if a process writes X , any successive write to X will see the effect of the first write
 - I.e., newer writes must wait for older ones to finish
 - E.g., local wiki edits (should never edit an older version than the most recent the client has) – may introduce merge conflicts with respect to other clients' changes!

Read-your-writes / Writes-follow-reads

- **Read-your-writes**: if a process writes X, any successive read to X will see the effect of the write
 - I.e., reads will never see old versions
 - Closely related to monotonic reads
 - Systems that often temporarily lack this consistency:
 - Retrieving websites
 - Updating passwords
- **Writes-follow-reads**: if a process reads X, any successive write to X will see the same value or a more recent one
 - I.e., writes will never see old versions
 - E.g., posts to an email list

Client-centric consistency

- Suppose a distributed news service guarantees nothing about consistency except that every news story posted will have a link to the most recent posted story. However, they will not necessarily be received by end users in the same order they are posted. Which client-centric consistency model most closely matches this description?
 - A. Monotonic reads
 - B. Monotonic writes
 - C. Read-your-writes
 - D. Writes-follow-reads
 - E. None of the above

Consistency protocols

- Continuous consistency protocols
 - **Bounding numerical deviation** (# of updates)
 - **Bounding staleness deviation** (time of updates)
- Primary-based protocols
 - **Primary**: one replica that coordinates all writes for a data item
 - **Remote-write**: forward all writes to primary (similar to write-through)
 - **Local-write**: periodic updates sent to primary (similar to write-back)
- Replicated-write protocols
 - **Active replication**: multicast updates to all replicas
 - Need a reliable and efficient multicast protocol
 - **Quorum-based voting**: replicas vote on updates to replicas
 - Need a distributed voting/consensus protocol

Distributed version control

