

CSMC 412

Operating Systems Prof. Ashok K Agrawala

Set 14

File-System Interface

- File Concept
- Access Methods
- Disk and Directory Structure
- File-System Mounting
- File Sharing
- Protection

Objectives

- To explain the function of file systems
- To describe the interfaces to file systems
- To discuss file-system design tradeoffs, including access methods, file sharing, file locking, and directory structures
- To explore file-system protection

File Concept

- Contiguous logical address space
 - Records
- Types:
 - Data
 - numeric
 - character
 - binary
 - Program
- Contents defined by file's creator
 - Many types
 - Consider **text file, source file, executable file**

File Attributes

- **Name** – only information kept in human-readable form
- **Identifier** – unique tag (number) identifies file within file system
- **Type** – needed for systems that support different types
- **Location** – pointer to file location on device
- **Size** – current file size
- **Protection** – controls who can do reading, writing, executing
- **Time, date, and user identification** – data for protection, security, and usage monitoring
- Information about files are kept in the directory structure, which is maintained on the disk
- Many variations, including extended file attributes such as file checksum
- Information kept in the directory structure

File info Window on Mac OS X

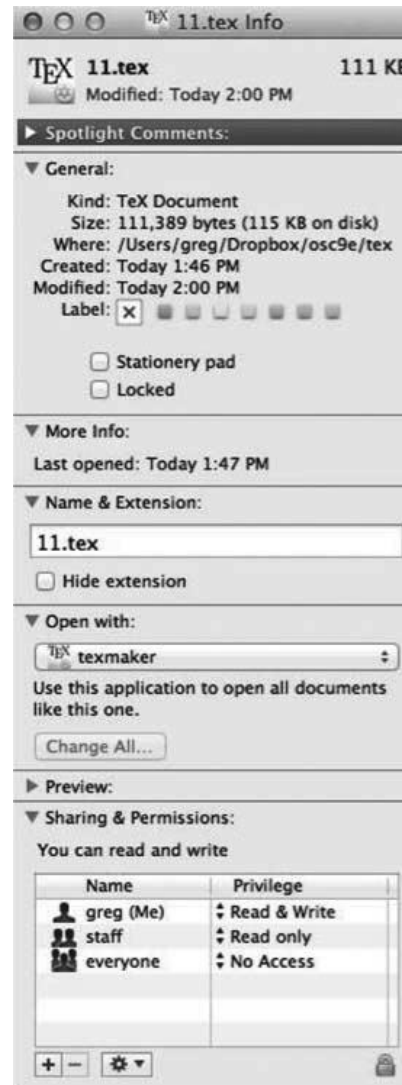

File Operations

- File is an **abstract data type**
- **Create**
- **Write** – at **write pointer** location
- **Read** – at **read pointer** location
- **Reposition within file - seek**
- **Delete**
- **Truncate**
- **$Open(F_i)$** – search the directory structure on disk for entry F_i , and move the content of entry to memory
- **$Close(F_i)$** – move the content of entry F_i in memory to directory structure on disk

Open Files

- Several pieces of data are needed to manage open files:
 - **Open-file table**: tracks open files
 - File pointer: pointer to last read/write location, per process that has the file open
 - **File-open count**: counter of number of times a file is open – to allow removal of data from open-file table when last processes closes it
 - Disk location of the file: cache of data access information
 - Access rights: per-process access mode information

Open File Locking

- Provided by some operating systems and file systems
 - Similar to reader-writer locks
 - **Shared lock** similar to reader lock – several processes can acquire concurrently
 - **Exclusive lock** similar to writer lock
- Mediates access to a file
- Mandatory or advisory:
 - **Mandatory** – access is denied depending on locks held and requested
 - **Advisory** – processes can find status of locks and decide what to do

File Locking Example – Java API

```
import java.io.*;
import java.nio.channels.*;
public class LockingExample {
    public static final boolean EXCLUSIVE = false;
    public static final boolean SHARED = true;
    public static void main(String arsg[]) throws IOException {
        FileLock sharedLock = null;
        FileLock exclusiveLock = null;
        try {
            RandomAccessFile raf = new RandomAccessFile("file.txt", "rw");
            // get the channel for the file
            FileChannel ch = raf.getChannel();
            // this locks the first half of the file - exclusive
            exclusiveLock = ch.lock(0, raf.length()/2, EXCLUSIVE);
            /** Now modify the data . . . */
            // release the lock
            exclusiveLock.release();
        }
    }
}
```

File Locking Example – Java API (Cont.)

```
        // this locks the second half of the file - shared
        sharedLock = ch.lock(raf.length()/2+1, raf.length(),           SHARED);
        /** Now read the data . . . */
        // release the lock
        sharedLock.release();
    } catch (java.io.IOException ioe) {
        System.err.println(ioe);
    }finally {
        if (exclusiveLock != null)
            exclusiveLock.release();
        if (sharedLock != null)
            sharedLock.release();
    }
}
}
```

File Name

- name used to uniquely identify a computer file stored in a file system.
- Name may include:
 - Host
 - Device
 - Path/Directory/Folder
 - File – base name
 - Type/Extension
 - Version
- Common names:

File Name	Contents
README	Project overview
MANIFEST	List of project files with brief explanations
INSTALL	Installation instructions
Copying	Licensing information
TODO	Wish list for future extensions
NEWS	Documentation on user-visible changes
Changes	Code change summary
configure	Platform configuration script
Makefile	Build specification
Makefile.SH	Shell script producing the above
config.h	Platform configuration definitions
config_h.SH	Shell script producing the above
patchlevel.h	Defines the project release version

File Types – Name, Extension

file type	usual extension	function
executable	exe, com, bin or none	ready-to-run machine-language program
object	obj, o	compiled, machine language, not linked
source code	c, cc, java, pas, asm, a	source code in various languages
batch	bat, sh	commands to the command interpreter
text	txt, doc	textual data, documents
word processor	wp, tex, rtf, doc	various word-processor formats
library	lib, a, so, dll	libraries of routines for programmers
print or view	ps, pdf, jpg	ASCII or binary file in a format for printing or viewing
archive	arc, zip, tar	related files grouped into one file, sometimes compressed, for archiving or storage
multimedia	mpeg, mov, rm, mp3, avi	binary file containing audio or A/V information

File Structure

- None - sequence of words, bytes
- Simple record structure
 - Lines
 - Fixed length
 - Variable length
- Complex Structures
 - Formatted document
 - Relocatable load file
- Can simulate last two with first method by inserting appropriate control characters
- Who decides:
 - Operating system
 - Program

Sequential-access File

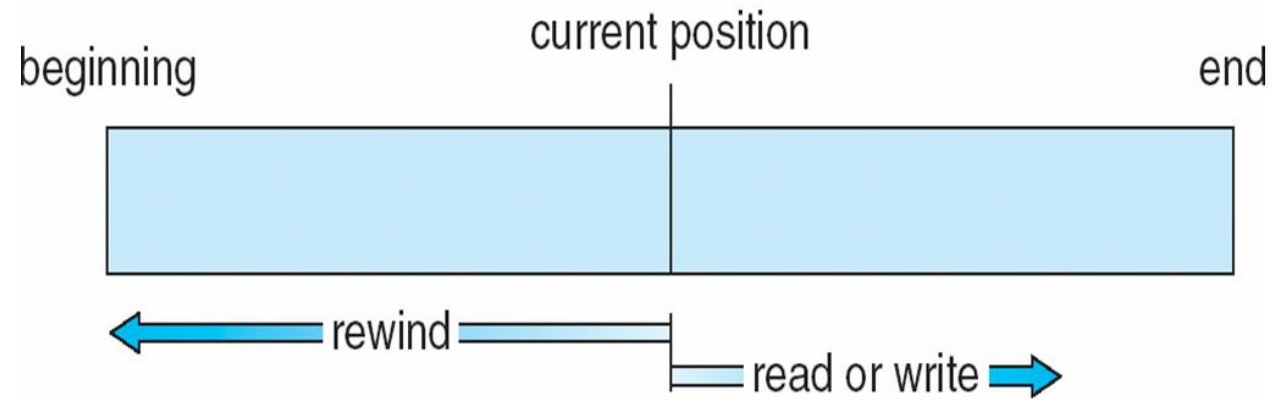

Access Methods

- **Sequential Access**

```
read next
write next
reset
no read after last write
    (rewrite)
```

- **Direct Access** – file is fixed length **logical records**

```
read n
write n
position to n
    read next
    write next
rewrite n
```

n = relative block number

- Relative block numbers allow OS to decide where file should be placed

Simulation of Sequential Access on Direct-access File

sequential access	implementation for direct access
<i>reset</i>	<i>cp = 0;</i>
<i>read next</i>	<i>read cp;</i> <i>cp = cp + 1;</i>
<i>write next</i>	<i>write cp;</i> <i>cp = cp + 1;</i>

Other Access Methods

- Can be built on top of base methods
- General involve creation of an **index** for the file
- Keep index in memory for fast determination of location of data to be operated on (consider UPC code plus record of data about that item)
- If too large, index (in memory) of the index (on disk)
- IBM indexed sequential-access method (ISAM)
 - Small master index, points to disk blocks of secondary index
 - File kept sorted on a defined key
 - All done by the OS
- VMS operating system provides index and relative files as another example (see next slide)

Example of Index and Relative Files

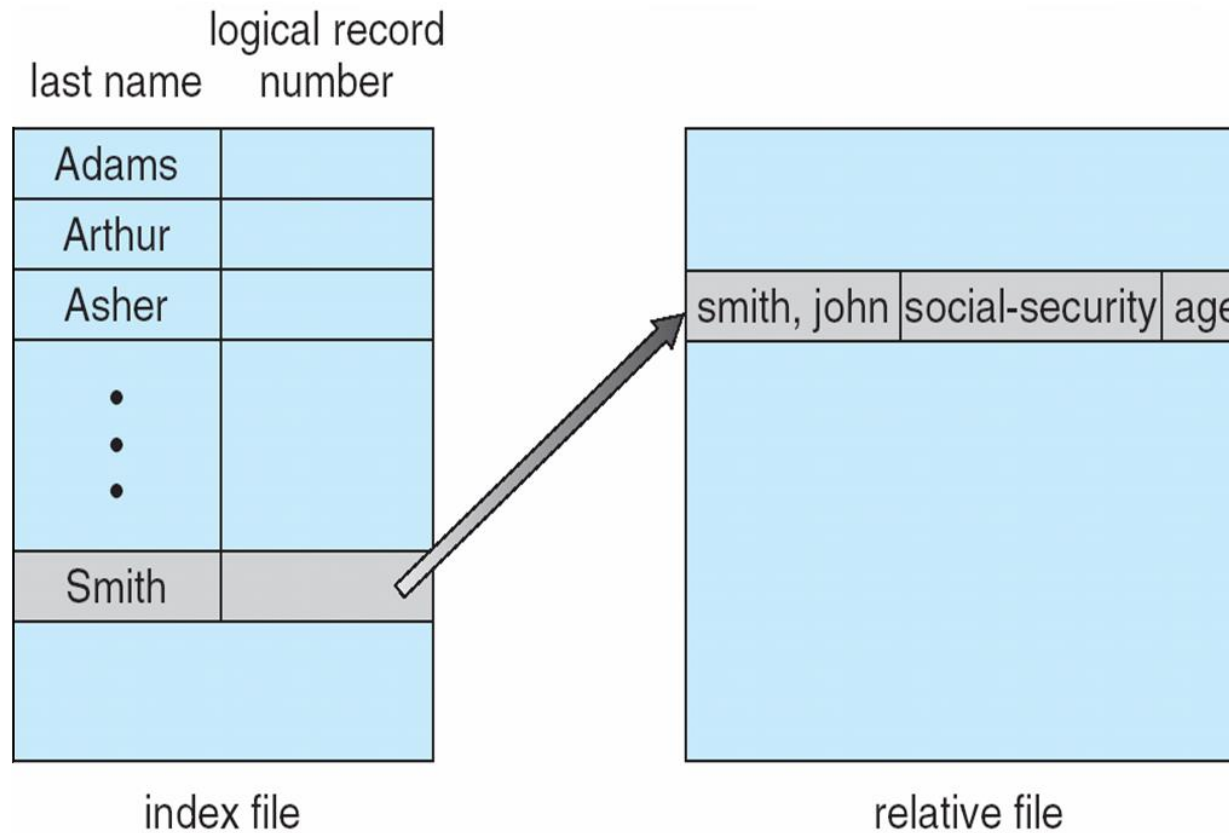

Directory Structure

- A collection of nodes containing information about all files

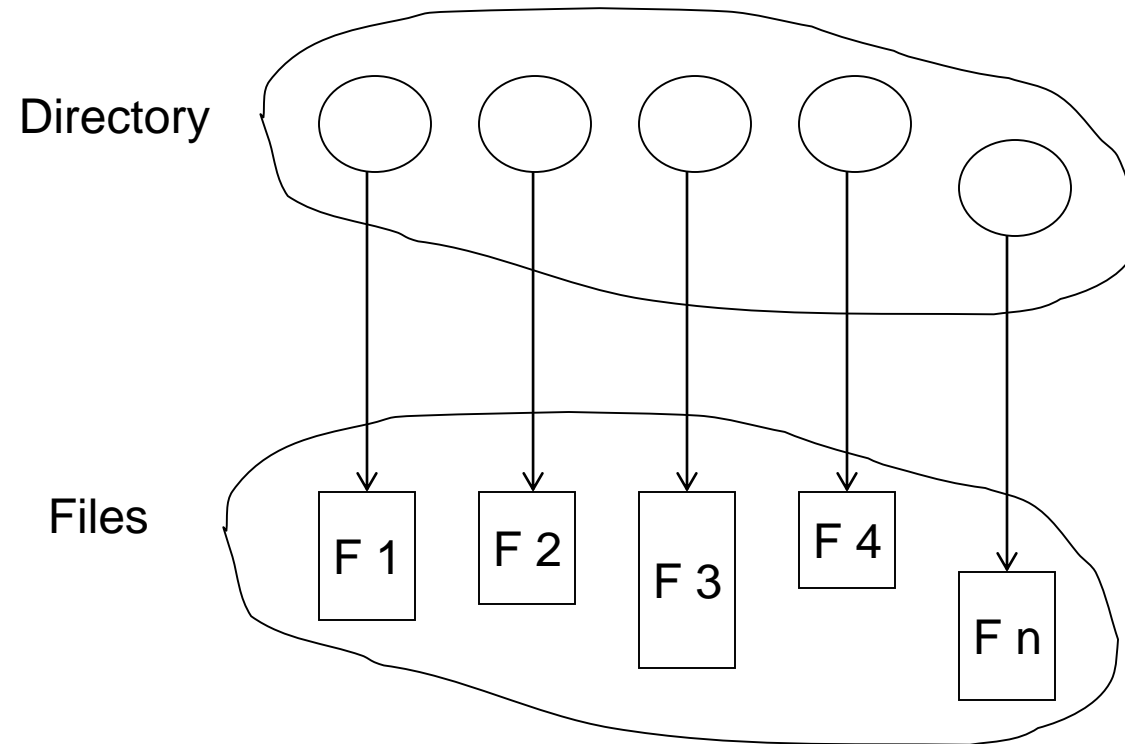

Both the directory structure and the files reside on disk

Disk Structure

- Disk can be subdivided into **partitions**
- Disks or partitions can be **RAID** protected against failure
- Disk or partition can be used **raw** – without a file system, or **formatted** with a file system
- Partitions also known as minidisks, slices
- Entity containing file system known as a **volume**
- Each volume containing file system also tracks that file system's info in **device directory** or **volume table of contents**
- As well as **general-purpose file systems** there are many **special-purpose file systems**, frequently all within the same operating system or computer

A Typical File-system Organization

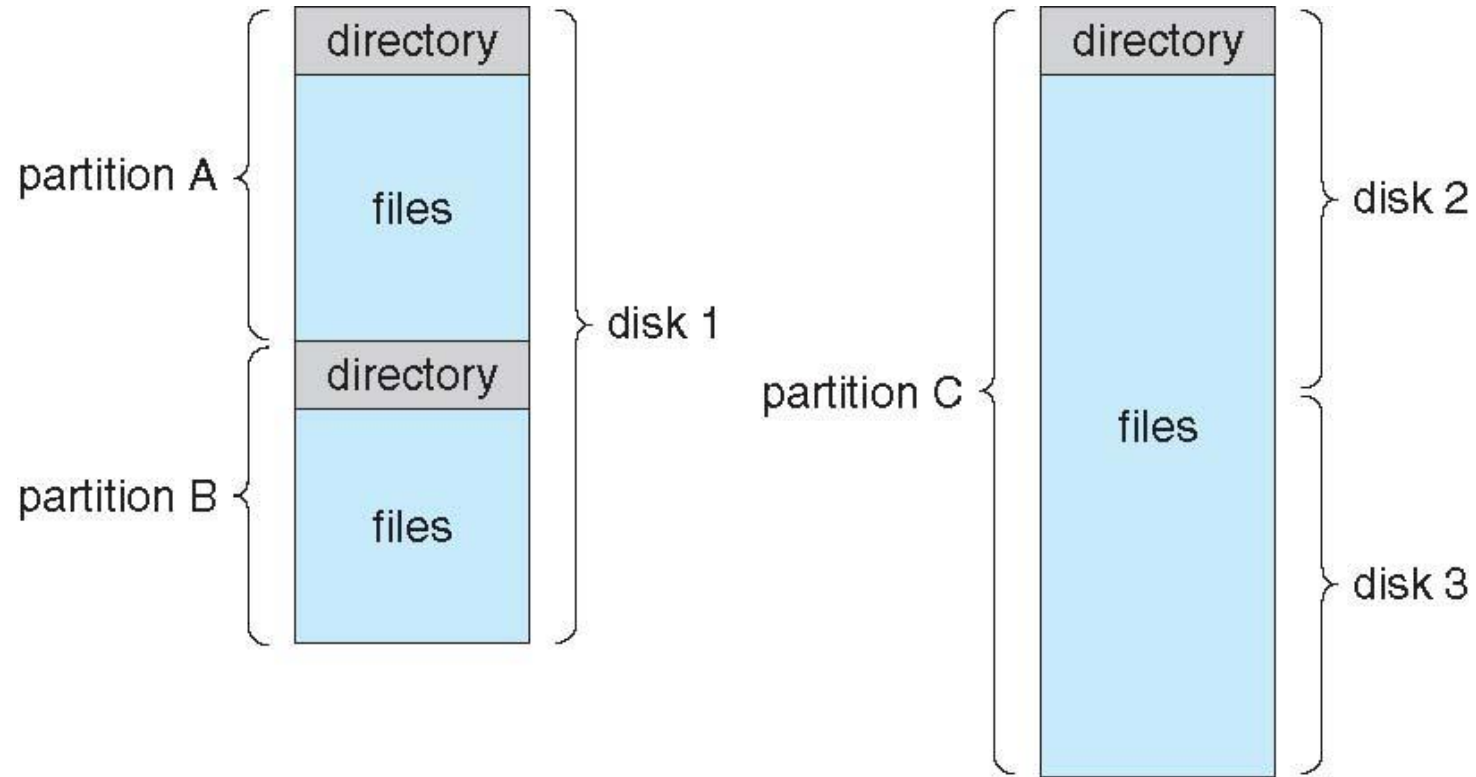

Types of File Systems

- We mostly talk of general-purpose file systems
- But systems frequently have many file systems, some general- and some special- purpose
- Consider Solaris has
 - tmpfs – memory-based volatile FS for fast, temporary I/O
 - objfs – interface into kernel memory to get kernel symbols for debugging
 - ctfs – contract file system for managing daemons
 - lofs – loopback file system allows one FS to be accessed in place of another
 - procfs – kernel interface to process structures
 - ufs, zfs – general purpose file systems

Operations Performed on Directory

- Search for a file
- Create a file
- Delete a file
- List a directory
- Rename a file
- Traverse the file system

Directory Organization

The directory is organized logically to obtain

- Efficiency – locating a file quickly
- Naming – convenient to users
 - Two users can have same name for different files
 - The same file can have several different names
- Grouping – logical grouping of files by properties, (e.g., all Java programs, all games, ...)

Single-Level Directory

- A single directory for all users

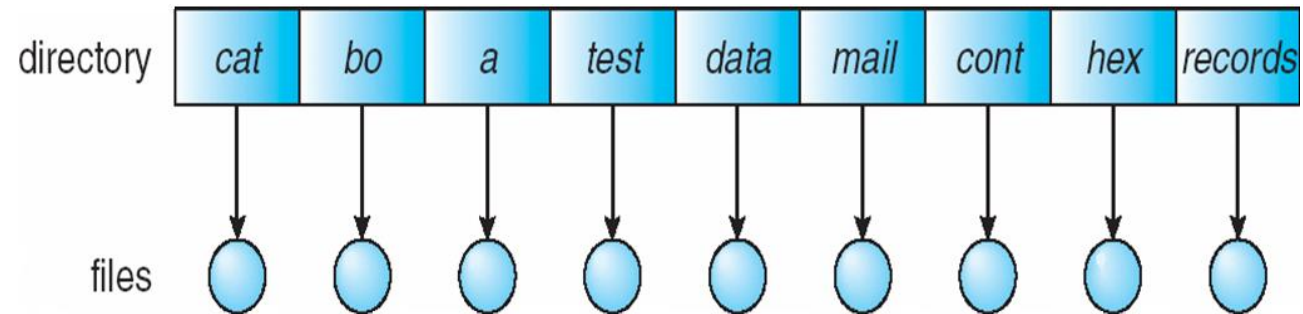

- Naming problem
- Grouping problem

Two-Level Directory

- Separate directory for each user

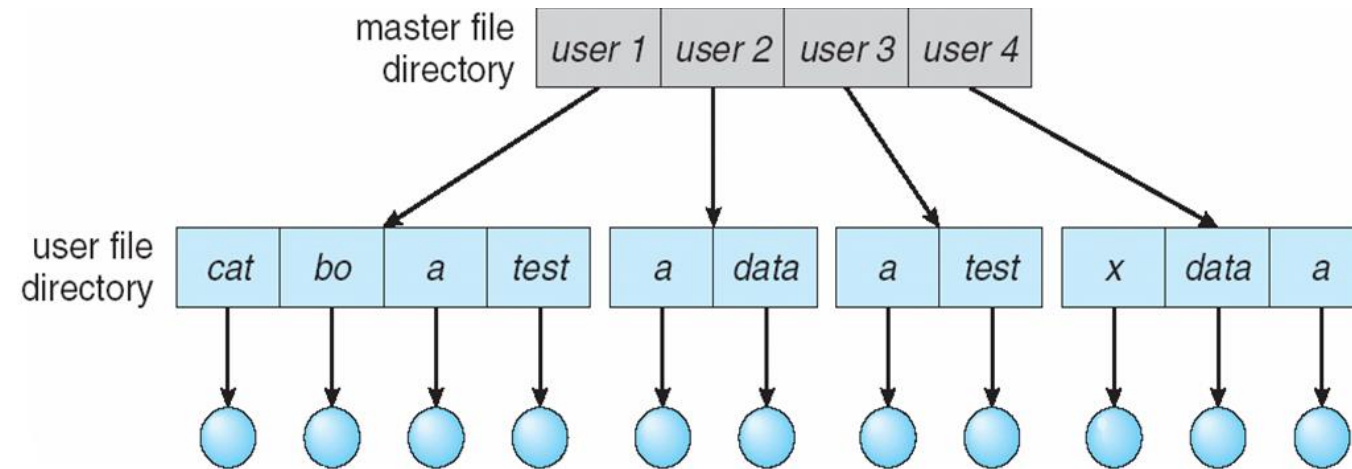

- ❑ Path name
- ❑ Can have the same file name for different user
- ❑ Efficient searching
- ❑ No grouping capability

Tree-Structured Directories

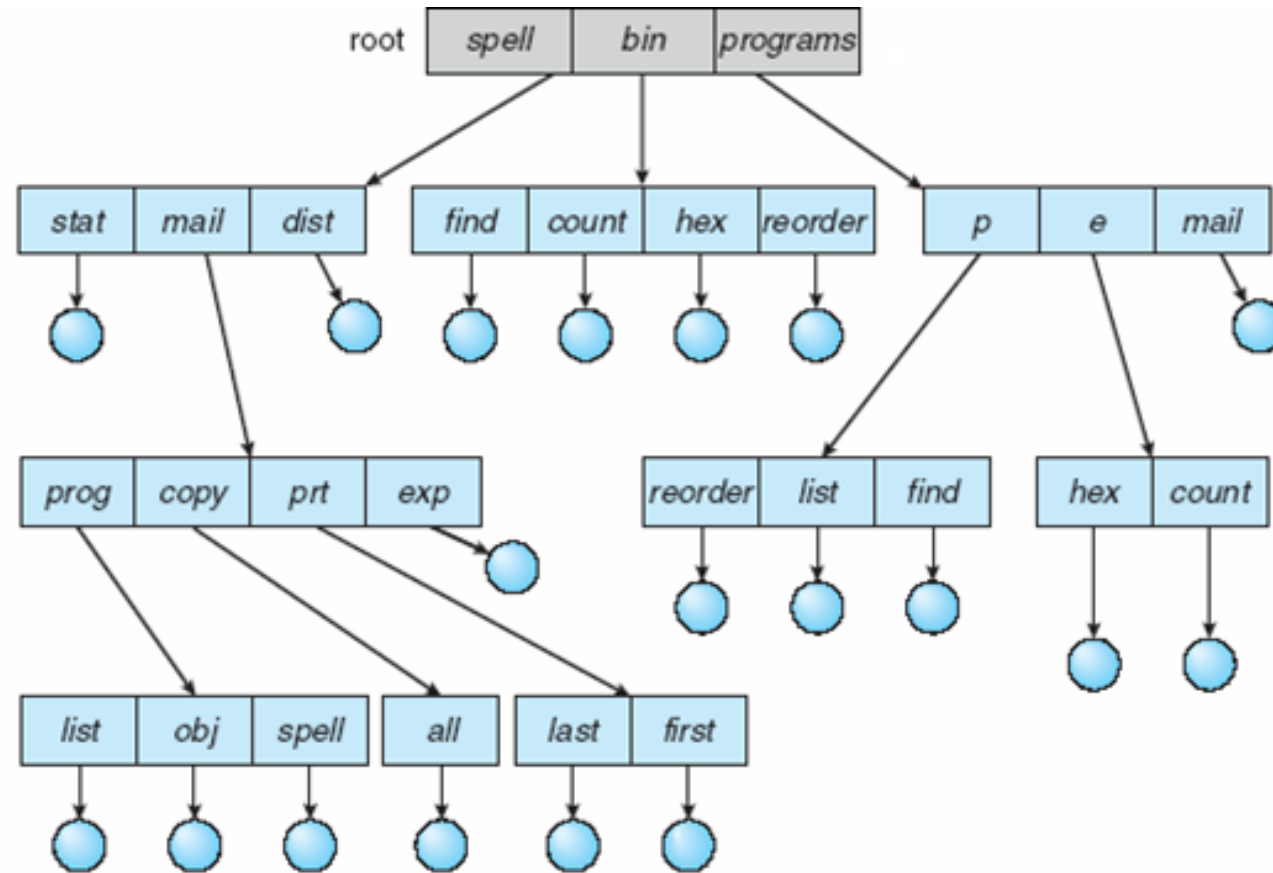

Tree-Structured Directories (Cont.)

- Efficient searching
- Grouping Capability
- Current directory (working directory)
 - `cd /spell/mail/prog`
 - `type list`

Tree-Structured Directories (Cont)

- **Absolute** or **relative** path name
- Creating a new file is done in current directory
- Delete a file

rm <file-name>

- Creating a new subdirectory is done in current directory

mkdir <dir-name>

Example: if in current directory **/mail**

mkdir count

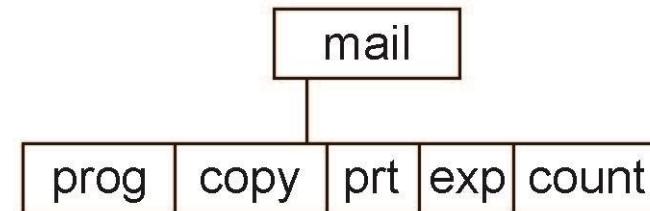

Deleting “mail” ⇒ deleting the entire subtree rooted by “mail”

Acyclic-Graph Directories

- Have shared subdirectories and files

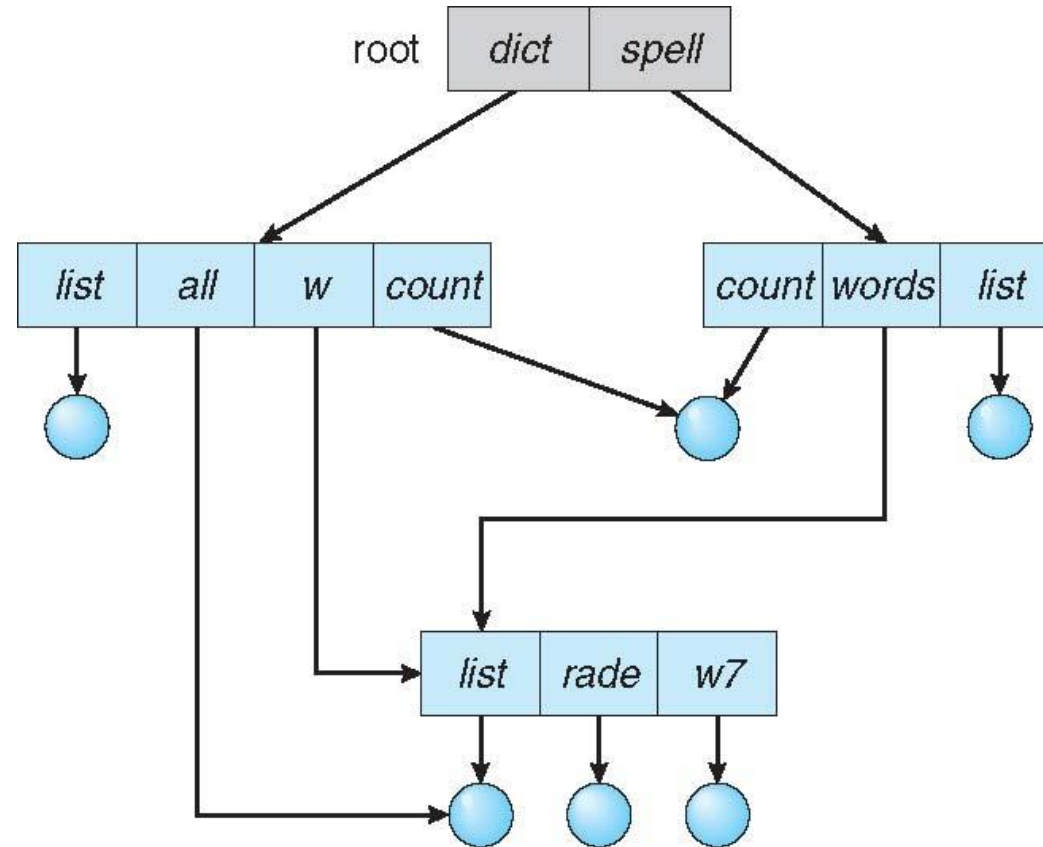

Acyclic-Graph Directories (Cont.)

- Two different names (aliasing)
- If ***dict*** deletes ***list*** \Rightarrow dangling pointer

Solutions:

- Backpointers, so we can delete all pointers
Variable size records a problem
- Backpointers using a daisy chain organization
- Entry-hold-count solution
- New directory entry type
 - **Link** – another name (pointer) to an existing file
 - **Resolve the link** – follow pointer to locate the file

General Graph Directory

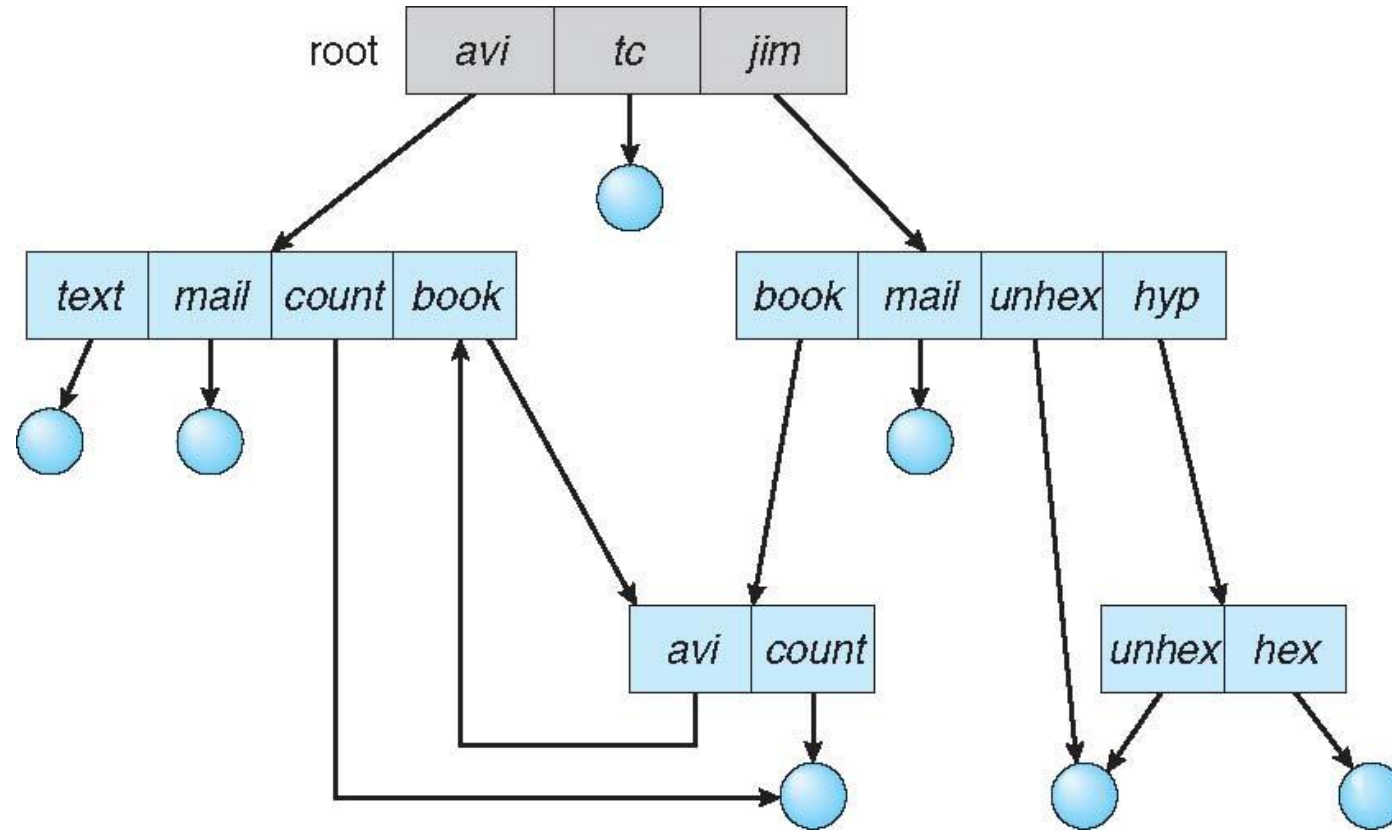

General Graph Directory (Cont.)

- How do we guarantee no cycles?
 - Allow only links to file not subdirectories
 - **Garbage collection**
 - Every time a new link is added use a cycle detection algorithm to determine whether it is OK

File System Mounting

- A file system must be **mounted** before it can be accessed
- A unmounted file system is mounted at a **mount point**

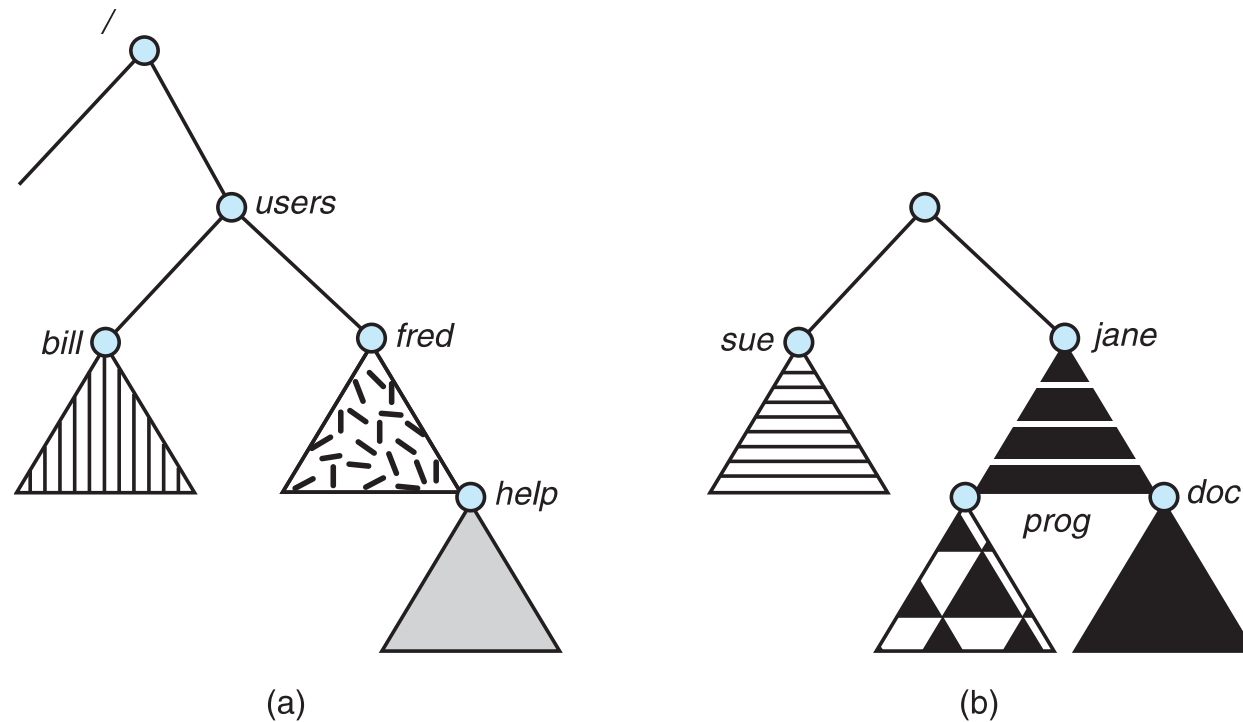

Mount Point

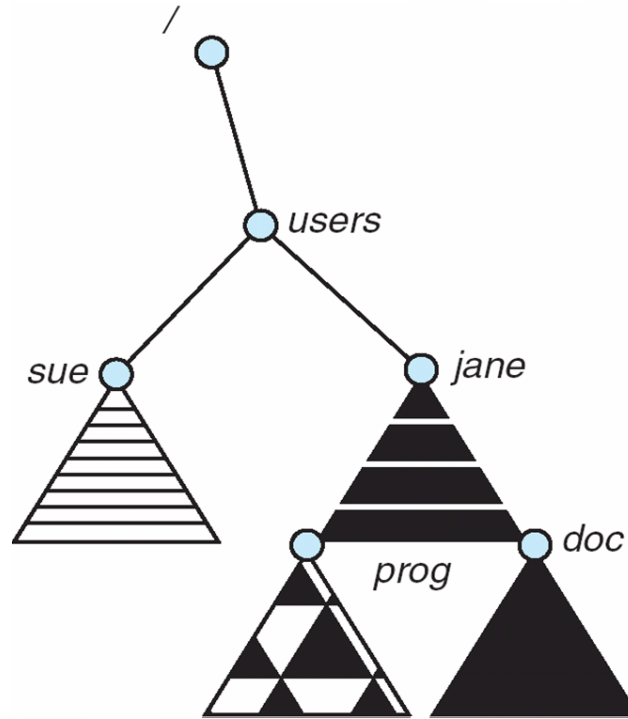

File Sharing

- Sharing of files on multi-user systems is desirable
- Sharing may be done through a **protection** scheme
- On distributed systems, files may be shared across a network
- Network File System (NFS) is a common distributed file-sharing method
- If multi-user system
 - **User IDs** identify users, allowing permissions and protections to be per-user
 - **Group IDs** allow users to be in groups, permitting group access rights
 - Owner of a file / directory
 - Group of a file / directory

File Sharing – Remote File Systems

- Uses networking to allow file system access between systems
 - Manually via programs like FTP
 - Automatically, seamlessly using **distributed file systems**
 - Semi automatically via the **world wide web**
- **Client-server** model allows clients to mount remote file systems from servers
 - Server can serve multiple clients
 - Client and user-on-client identification is insecure or complicated
 - **NFS** is standard UNIX client-server file sharing protocol
 - **CIFS** is standard Windows protocol
 - Standard operating system file calls are translated into remote calls
- Distributed Information Systems (**distributed naming services**) such as LDAP, DNS, NIS, Active Directory implement unified access to information needed for remote computing

File Sharing – Failure Modes

- All file systems have failure modes
 - For example corruption of directory structures or other non-user data, called **metadata**
- Remote file systems add new failure modes, due to network failure, server failure
- Recovery from failure can involve **state information** about status of each remote request
- **Stateless** protocols such as NFS v3 include all information in each request, allowing easy recovery but less security

File Sharing – Consistency Semantics

- Specify how multiple users are to access a shared file simultaneously
 - Similar to process synchronization algorithms
 - Tend to be less complex due to disk I/O and network latency (for remote file systems)
 - Andrew File System (AFS) implemented complex remote file sharing semantics
 - Unix file system (UFS) implements:
 - Writes to an open file visible immediately to other users of the same open file
 - Sharing file pointer to allow multiple users to read and write concurrently
 - AFS has session semantics
 - Writes only visible to sessions starting after the file is closed

Protection

- File owner/creator should be able to control:
 - what can be done
 - by whom
- Types of access
 - **Read**
 - **Write**
 - **Execute**
 - **Append**
 - **Delete**
 - **List**

Access Lists and Groups

- Mode of access: read, write, execute
- Three classes of users on Unix / Linux

a) owner access	7	⇒	RWX 1 1 1
b) group access	6	⇒	RWX 1 1 0
c) public access	1	⇒	RWX 0 0 1

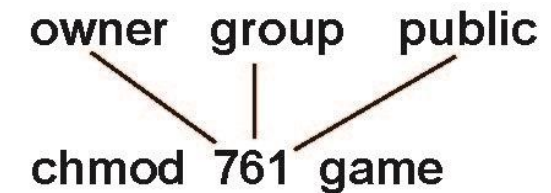

- Ask manager to create a group (unique name), say G, and add some users to the group.
- For a particular file (say *game*) or subdirectory, define an appropriate access.

Attach a group to a file

chgrp G game

Windows 7 Access-Control List Management

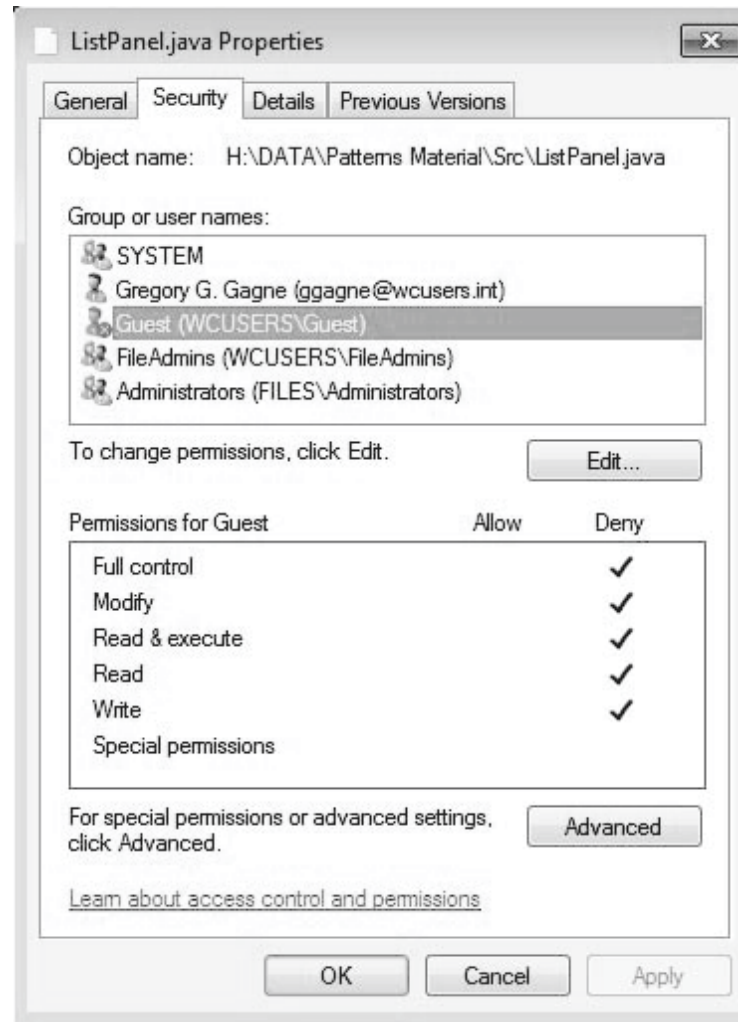

A Sample UNIX Directory Listing

```
-rw-rw-r-- 1 pbg  staff  31200  Sep 3 08:30  intro.ps
drwx----- 5 pbg  staff    512  Jul 8 09:33  private/
drwxrwxr-x 2 pbg  staff    512  Jul 8 09:35  doc/
drwxrwx--- 2 pbg  student  512  Aug 3 14:13  student-proj/
-rw-r--r-- 1 pbg  staff  9423  Feb 24 2003  program.c
-rwxr-xr-x 1 pbg  staff 20471  Feb 24 2003  program
drwx--x--x 4 pbg  faculty  512  Jul 31 10:31  lib/
drwx----- 3 pbg  staff  1024  Aug 29 06:52  mail/
drwxrwxrwx 3 pbg  staff    512  Jul 8 09:35  test/
```