

CMSC 330: Organization of Programming Languages

Context Free Grammars

Recall: Interpreters

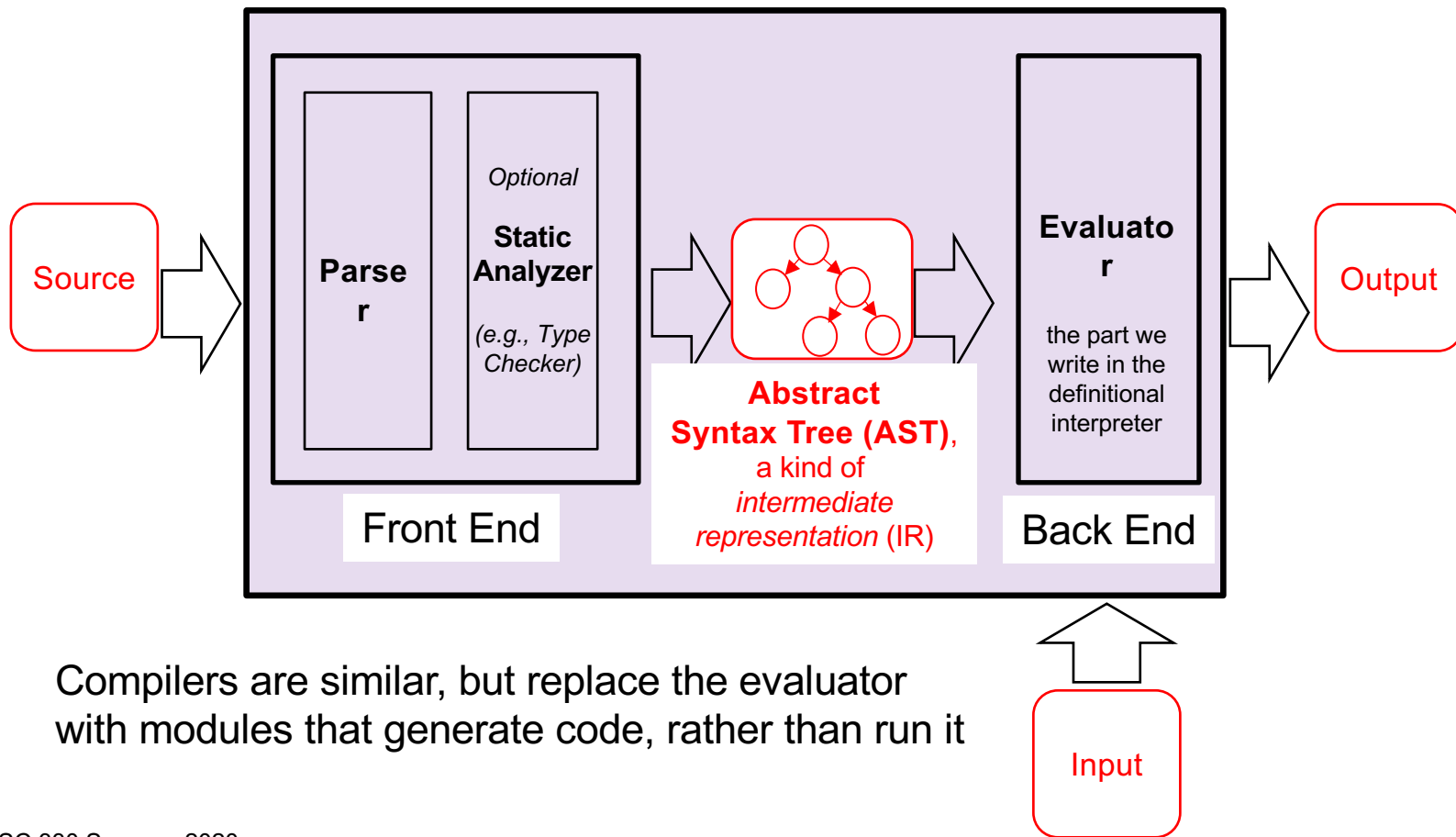

Compilers are similar, but replace the evaluator with modules that generate code, rather than run it

Implementing the Front End

- ▶ Goal: Convert program text into an AST
 - Abstract Syntax Tree
- ▶ ASTs are easier to work with
 - Analyze, optimize, execute the program
- ▶ Idea: Do this using regular expressions?
 - **Won't work!**
 - Regular expressions cannot reliably parse paired braces `{ { ... } }`, parentheses `(((...)))`, etc.
- ▶ Instead: Regexp for tokens (**scanning**), and **Context Free Grammars** for **parsing** tokens

Front End – Scanner and Parser

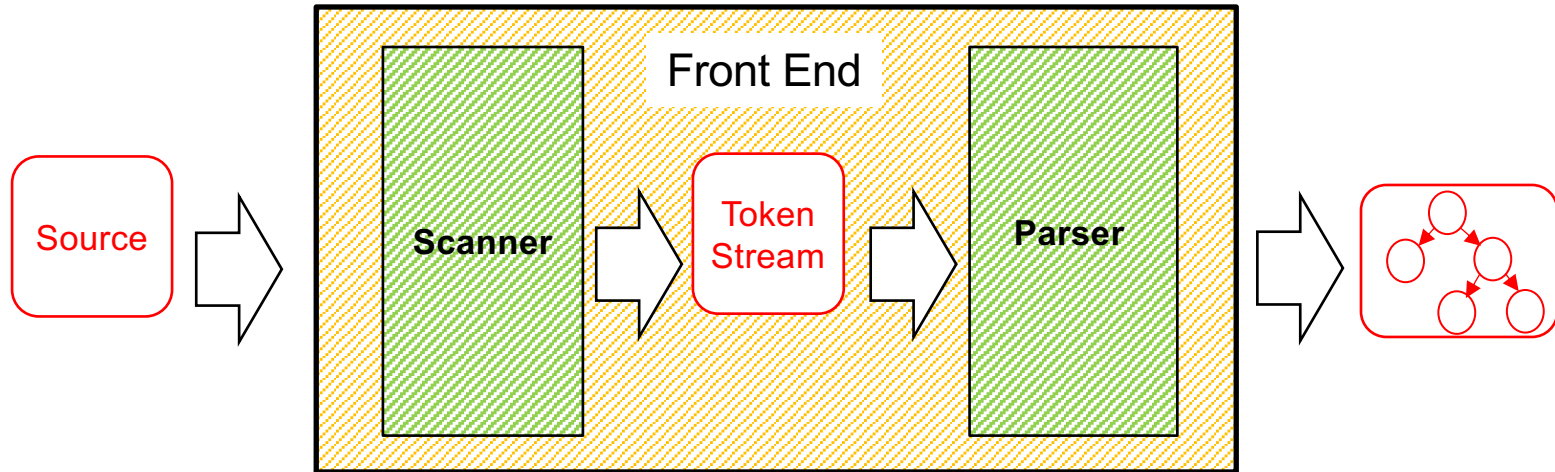

- **Scanner / lexer** converts program source into **tokens** (keywords, variable names, operators, numbers, etc.) using **regular expressions**
- **Parser** converts tokens into an **AST** (abstract syntax tree). Parsers recognize strings defined as **context free grammars**

Context-Free Grammar (CFG)

- ▶ A way of describing **sets of strings** (= languages)
 - The notation $L(G)$ denotes the language of strings defined by grammar G
- ▶ Example grammar G is $S \rightarrow 0S \mid 1S \mid \varepsilon$
which says that string $s' \in L(G)$ iff
 - $s' = \varepsilon$, or $\exists s \in L(G)$ such that $s' = 0s$, or $s' = 1s$
- ▶ Grammar is same as regular expression $(0|1)^*$
 - Generates / accepts the same set of strings

CFGs Are Expressive

- ▶ CFGs **subsume** REs, DFAs, NFAs
 - There is a CFG that generates any regular language
 - But: REs are often better notation for those languages
- ▶ And CFGs can define languages regexps cannot
 - $S \rightarrow (S) \mid \varepsilon$ // represents balanced pairs of ()'s
- ▶ As a result, CFGs often used as the basis of **parsers** for programming languages

Parsing with CFGs

- ▶ CFGs formally define languages, but they **do not** define an *algorithm* for accepting strings
- ▶ Several styles of algorithm; each works only for less expressive forms of CFG
 - LL(k) parsing ← We will discuss this next lecture
 - LR(k) parsing
 - LALR(k) parsing
 - SLR(k) parsing
- ▶ Tools exist for building parsers from grammars
 - JavaCC, Yacc, etc.

Formal Definition: Context-Free Grammar

- ▶ A CFG G is a 4-tuple (Σ, N, P, S)
 - Σ – alphabet (finite set of symbols, or terminals)
 - Often written in lowercase
 - N – a finite, nonempty set of nonterminal symbols
 - Often written in UPPERCASE
 - It must be that $N \cap \Sigma = \emptyset$
 - P – a set of productions of the form $N \rightarrow (\Sigma|N)^*$
 - Informally: the nonterminal can be replaced by the string of zero or more terminals / nonterminals to the right of the \rightarrow
 - Can think of productions as rewriting rules (more later)
 - $S \in N$ – the start symbol

Notational Shortcuts

$S \rightarrow aBc$	$S \rightarrow aBc$	// S is start symbol
$A \rightarrow aA$		
b		// A \rightarrow b
		// A $\rightarrow \epsilon$

- ▶ A production is of the form
 - left-hand side (LHS) \rightarrow right hand side (RHS)
- ▶ If not specified
 - Assume LHS of first production is the start symbol
- ▶ Productions with the same LHS
 - Are usually combined with |
- ▶ If a production has an empty RHS
 - It means the RHS is ϵ

Backus-Naur Form

- ▶ Context-free grammar production rules are also called Backus-Naur Form or **BNF**
 - Designed by John Backus and Peter Naur
 - Chair and Secretary of the Algol committee in the early 1960s. Used this notation to describe Algol in 1962
- ▶ A production $A \rightarrow B c D$ is written in BNF as $\langle A \rangle ::= \langle B \rangle c \langle D \rangle$
 - Non-terminals written with angle brackets and uses $::=$ instead of \rightarrow
 - Often see hybrids that use $::=$ instead of \rightarrow but drop the angle brackets on non-terminals, favoring *italics*

Generating Strings

- ▶ We can think of a grammar as **generating** strings by rewriting

- ▶ Example grammar **G**

$$S \rightarrow 0S \mid 1S \mid \varepsilon$$

- ▶ Generate string 011 from **G** as follows:

$$S \Rightarrow 0S \quad // \text{ using } S \rightarrow 0S$$

$$\Rightarrow 01S \quad // \text{ using } S \rightarrow 1S$$

$$\Rightarrow 011S \quad // \text{ using } S \rightarrow 1S$$

$$\Rightarrow 011 \quad // \text{ using } S \rightarrow \varepsilon$$

Accepting Strings (Informally)

- ▶ Checking if $s \in L(G)$ is called **acceptance**
 - Algorithm: Find a **rewriting** starting from G 's start symbol that yields s
 - A rewriting is some sequence of productions (**rewrites**) applied starting at the start symbol
 - $011 \in L(G)$ according to the previous rewriting
- ▶ Terminology
 - Such a sequence of rewrites is a **derivation** or **parse**
 - Discovering the derivation is called **parsing**

Derivations

▶ Notation

- \Rightarrow indicates a derivation of one step
- \Rightarrow^+ indicates a derivation of one or more steps
- \Rightarrow^* indicates a derivation of zero or more steps

▶ Example

- $S \rightarrow 0S \mid 1S \mid \varepsilon$

▶ For the string 010

- $S \Rightarrow 0S \Rightarrow 01S \Rightarrow 010S \Rightarrow 010$
- $S \Rightarrow^+ 010$
- $010 \Rightarrow^* 010$

Language Generated by Grammar

- ▶ $L(G)$ the language defined by G is

$$L(G) = \{ s \in \Sigma^* \mid S \Rightarrow^+ s \}$$

- S is the start symbol of the grammar
 - Σ is the alphabet for that grammar
- ▶ In other words
 - All strings over Σ that can be derived from the start symbol via one or more productions

Quiz #1

Consider the grammar

$$S \rightarrow bS \mid T$$

$$T \rightarrow aT \mid U$$

$$U \rightarrow cU \mid \varepsilon$$

Which of the following strings is generated by this grammar?

A. aba

B. ccc

C. bab

D. ca

Quiz #1

Consider the grammar

$$S \rightarrow bS \mid T$$

$$T \rightarrow aT \mid U$$

$$U \rightarrow cU \mid \epsilon$$

Which of the following strings is generated by this grammar?

A. aba

B. ccc

C. bab

D. ca

Quiz #2

Consider the grammar

$$S \rightarrow bS \mid T$$

$$T \rightarrow aT \mid U$$

$$U \rightarrow cU \mid \varepsilon$$

Which of the following is a derivation of the string **aac**?

A. $S \Rightarrow T \Rightarrow aT \Rightarrow aTaT \Rightarrow aaT \Rightarrow aacU \Rightarrow aac$

B. $S \Rightarrow T \Rightarrow U \Rightarrow aU \Rightarrow aaU \Rightarrow aacU \Rightarrow aac$

C. $S \Rightarrow aT \Rightarrow aaT \Rightarrow aaU \Rightarrow aacU \Rightarrow aac$

D. $S \Rightarrow T \Rightarrow aT \Rightarrow aaT \Rightarrow aaU \Rightarrow aacU \Rightarrow aac$

Quiz #2

- ▶ Consider the grammar

$$S \rightarrow bS \mid T$$

$$T \rightarrow aT \mid U$$

$$U \rightarrow cU \mid \varepsilon$$

- ▶ Which of the following is a derivation of the string **aac**?

A. $S \Rightarrow T \Rightarrow aT \Rightarrow aTaT \Rightarrow aaT \Rightarrow aacU \Rightarrow aac$

B. $S \Rightarrow T \Rightarrow U \Rightarrow aU \Rightarrow aaU \Rightarrow aacU \Rightarrow aac$

C. $S \Rightarrow aT \Rightarrow aaT \Rightarrow aaU \Rightarrow aacU \Rightarrow aac$

D. $S \Rightarrow T \Rightarrow aT \Rightarrow aaT \Rightarrow aaU \Rightarrow aacU \Rightarrow aac$

Quiz #3

Consider the grammar

$$S \rightarrow bS \mid T$$

$$T \rightarrow aT \mid U$$

$$U \rightarrow cU \mid \varepsilon$$

Which of the following regular expressions accepts the same language as this grammar?

A. $(a|b|c)^*$

B. $b^*a^*c^*$

C. $(b|ba|bac)^*$

D. bac^*

Quiz #3

Consider the grammar

$$S \rightarrow bS \mid T$$

$$T \rightarrow aT \mid U$$

$$U \rightarrow cU \mid \varepsilon$$

Which of the following regular expressions accepts the same language as this grammar?

A. $(a|b|c)^*$

B. $b^*a^*c^*$

C. $(b|ba|bac)^*$

D. bac^*

Designing Grammars

1. Use recursive productions to generate an arbitrary number of symbols

$A \rightarrow xA \mid \epsilon$ // Zero or more x 's

$A \rightarrow yA \mid y$ // One or more y 's

2. Use separate non-terminals to generate disjoint parts of a language, and then combine in a production

a^*b^* // a 's followed by b 's

$S \rightarrow AB$

$A \rightarrow aA \mid \epsilon$ // Zero or more a 's

$B \rightarrow bB \mid \epsilon$ // Zero or more b 's

Designing Grammars

3. To generate languages with matching, balanced, or related numbers of symbols, write productions which generate strings from the middle

$\{a^n b^n \mid n \geq 0\}$ // N a' s followed by N b' s

$S \rightarrow aSb \mid \varepsilon$

Example derivation: $S \Rightarrow aSb \Rightarrow aaSbb \Rightarrow aabb$

$\{a^n b^{2n} \mid n \geq 0\}$ // N a' s followed by 2N b' s

$S \rightarrow aSbb \mid \varepsilon$

Example derivation: $S \Rightarrow aSbb \Rightarrow aaSbbbb \Rightarrow aabbbb$

Designing Grammars

4. For a language that is the union of other languages, use separate nonterminals for each part of the union and then combine

$$\{ a^n(b^m|c^m) \mid m > n \geq 0 \}$$

Can be rewritten as

$$\{ a^n b^m \mid m > n \geq 0 \} \cup \{ a^n c^m \mid m > n \geq 0 \}$$

$$S \rightarrow T \mid V$$

$$T \rightarrow aTb \mid U$$

$$U \rightarrow Ub \mid b$$

$$V \rightarrow aVc \mid W$$

$$W \rightarrow Wc \mid c$$

Practice

- ▶ Try to make a grammar which accepts

- $0^*|1^*$
- 0^n1^n where $n \geq 0$

$$S \rightarrow A \mid B$$

$$A \rightarrow 0A \mid \varepsilon \quad S \rightarrow 0S1 \mid \varepsilon$$

$$B \rightarrow 1B \mid \varepsilon$$

- ▶ Give some example strings from this language

- $S \rightarrow 0 \mid 1S$
 - 0, 10, 110, 1110, 11110, ...
- What language is it, as a regexp?
 - 1^*0

Quiz #4

Which of the following grammars describes the same language as $0^n 1^m$ where $m \leq n$?

- A. $S \rightarrow 0S1 \mid \varepsilon$ //same number of 0 and 1
- B. $S \rightarrow 0S1 \mid S1 \mid \varepsilon$ //more 1's
- C. $S \rightarrow 0S1 \mid 0S \mid \varepsilon$ //more 0's
- D. $S \rightarrow SS \mid 0 \mid 1 \mid \varepsilon$ //no control of the number

Quiz #4

Which of the following grammars describes the same language as $0^n 1^m$ where $m \leq n$?

A. $S \rightarrow 0S1 \mid \epsilon$

B. $S \rightarrow 0S1 \mid S1 \mid \epsilon$

C. $S \rightarrow 0S1 \mid 0S \mid \epsilon$

D. $S \rightarrow SS \mid 0 \mid 1 \mid \epsilon$

CFGs for Language Syntax

- ▶ When discussing operational semantics, we used BNF-style grammars to define ASTs

$$e ::= x \mid n \mid e + e \mid \text{let } x = e \text{ in } e$$

- This grammar defined an AST for expressions synonymous with an OCaml datatype
- ▶ We can *also* use this grammar to define a language parser
 - However, while it is fine for defining ASTs, this grammar, if used directly for parsing, is **ambiguous**

Arithmetic Expressions

- ▶ $E \rightarrow a \mid b \mid c \mid E+E \mid E-E \mid E^*E \mid (E)$
 - An expression E is either a letter a , b , or c
 - Or an E followed by $+$ followed by an E
 - etc...
- ▶ This **describes** (or **generates**) a set of strings
 - $\{a, b, c, a+b, a+a, a^*c, a-(b^*a), c^*(b+a), \dots\}$
- ▶ Example strings not in the language
 - $d, c(a), a+, b^{**}c$, etc.

Parse Trees

- ▶ Parse tree shows how a string is produced by a grammar
 - Root node is the start symbol
 - Every internal node is a nonterminal
 - Children of an internal node
 - Are symbols on RHS of production applied to nonterminal
 - Every leaf node is a terminal or ϵ

- ▶ Reading the leaves left to right
 - Shows the string corresponding to the tree

Parse Tree Example

S

S

$S \rightarrow aS \mid T$

$T \rightarrow bT \mid U$

$U \rightarrow cU \mid \varepsilon$

Parse Tree Example

$S \Rightarrow aS$

$S \rightarrow aS \mid T$

$T \rightarrow bT \mid U$

$U \rightarrow cU \mid \varepsilon$

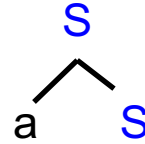

Parse Tree Example

$$S \Rightarrow aS \Rightarrow aT$$

$$S \rightarrow aS \mid T$$

$$T \rightarrow bT \mid U$$

$$U \rightarrow cU \mid \varepsilon$$

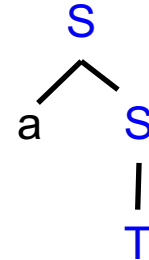

Parse Tree Example

$S \Rightarrow aS \Rightarrow aT \Rightarrow aU$

$S \rightarrow aS \mid T$

$T \rightarrow bT \mid U$

$U \rightarrow cU \mid \varepsilon$

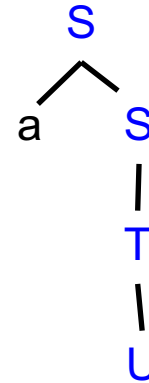

Parse Tree Example

$S \Rightarrow aS \Rightarrow aT \Rightarrow aU \Rightarrow acU$

$S \rightarrow aS \mid T$

$T \rightarrow bT \mid U$

$U \rightarrow cU \mid \varepsilon$

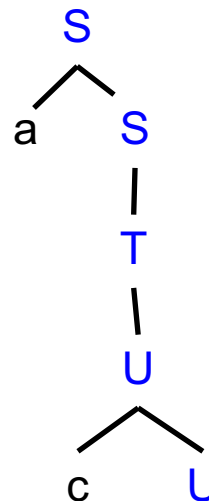

Parse Tree Example

$S \Rightarrow aS \Rightarrow aT \Rightarrow aU \Rightarrow acU \Rightarrow ac$

$S \rightarrow aS \mid T$

$T \rightarrow bT \mid U$

$U \rightarrow cU \mid \varepsilon$

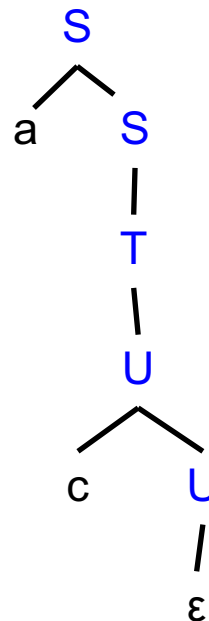

Parse Trees for Expressions

- ▶ A **parse tree** shows the structure of an expression as it corresponds to a grammar

$$E \rightarrow a \mid b \mid c \mid d \mid E+E \mid E-E \mid E^*E \mid (E)$$

a

a^*c

$c^*(b+d)$

Parse Trees for Expressions

- ▶ A **parse tree** shows the structure of an expression as it corresponds to a grammar

$$E \rightarrow a \mid b \mid c \mid d \mid E+E \mid E-E \mid E^*E \mid (E)$$

a



a*c

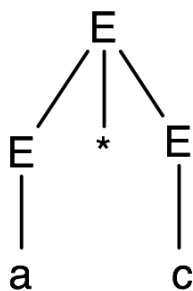

c*(b+d)

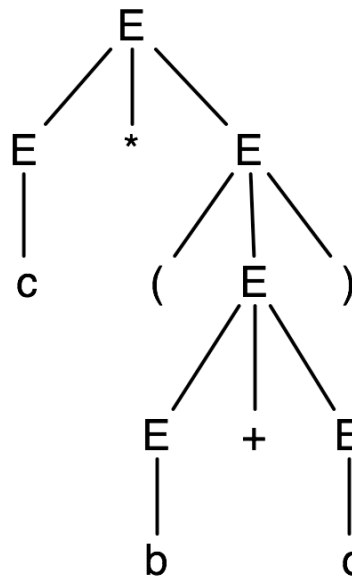

Abstract Syntax Trees

- ▶ A **parse tree** and an **AST** are **not the same thing**
 - The latter is a data structure produced by parsing

`a*c`

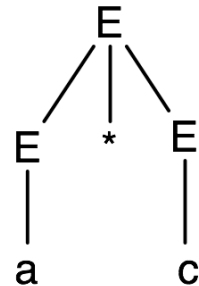

`c*(b+d)`

Parse trees

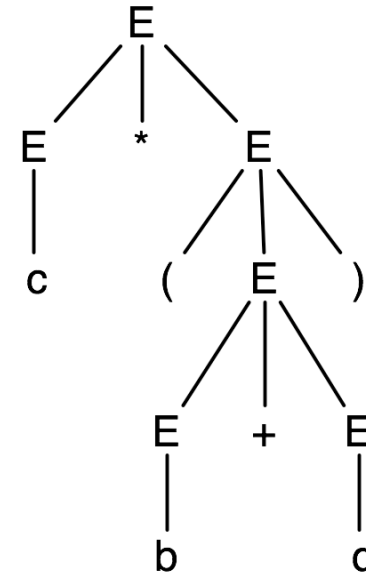

ASTs

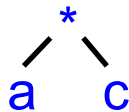

`Mult (Var ("a"), Var ("c"))`

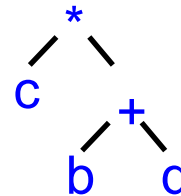

`Mult (Var ("c"), Plus (Var ("b"), Var ("d"))))`

Practice

$E \rightarrow a \mid b \mid c \mid d \mid E+E \mid E-E \mid E^*E \mid (E)$

Make a parse tree for...

- a^*b
- $a+(b-c)$
- $d^*(d+b)-a$
- $(a+b)^*(c-d)$
- $a+(b-c)^*d$

Leftmost and Rightmost Derivation

- ▶ Leftmost derivation
 - Leftmost nonterminal is replaced in each step
- ▶ Rightmost derivation
 - Rightmost nonterminal is replaced in each step
- ▶ Example
 - Grammar
 - $S \rightarrow AB, A \rightarrow a, B \rightarrow b$
 - Leftmost derivation for “ab”
 - $S \Rightarrow AB \Rightarrow aB \Rightarrow ab$
 - Rightmost derivation for “ab”
 - $S \Rightarrow AB \Rightarrow Ab \Rightarrow ab$

Parse Tree For Derivations

- ▶ Parse tree may be same for both leftmost & rightmost derivations

- Example Grammar: $S \rightarrow a \mid SbS$ String: aba

Leftmost Derivation

$S \Rightarrow SbS \Rightarrow abS \Rightarrow aba$

Rightmost Derivation

$S \Rightarrow SbS \Rightarrow Sba \Rightarrow aba$

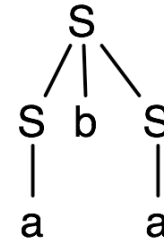

- Parse trees don't show order productions are applied
- Every parse tree has a unique leftmost and a unique rightmost derivation

Parse Tree For Derivations (cont.)

- ▶ Not every string has a unique parse tree

- Example Grammar: $S \rightarrow a \mid SbS$ String: **ababa**

Leftmost Derivation

$S \Rightarrow SbS \Rightarrow abS \Rightarrow abSbS \Rightarrow ababS \Rightarrow ababa$

Another Leftmost Derivation

$S \Rightarrow SbS \Rightarrow SbSbS \Rightarrow abSbS \Rightarrow ababS \Rightarrow ababa$

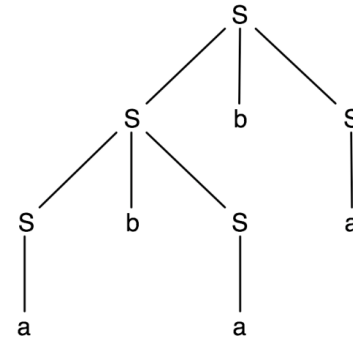
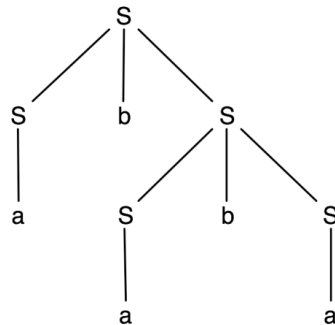

Ambiguity

- ▶ A grammar is **ambiguous** if a string may have multiple **leftmost** derivations

I saw a girl with a telescope.



Ambiguity

- ▶ A grammar is **ambiguous** if a string may have multiple **leftmost** derivations

- Equivalent to multiple parse trees
- Can be hard to determine

1. $S \rightarrow aS \mid T$

$T \rightarrow bT \mid U$

$U \rightarrow cU \mid \varepsilon$

No

2. $S \rightarrow T \mid T$

$T \rightarrow Tx \mid Tx \mid x \mid x$

Yes

3. $S \rightarrow SS \mid () \mid (S)$

?

Ambiguity (cont.)

▶ Example

- Grammar: $S \rightarrow SS \mid () \mid (S)$ String: $()()()$
- 2 distinct (leftmost) derivations (and parse trees)
 - $S \Rightarrow \underline{SS} \Rightarrow \underline{SSS} \Rightarrow ()\underline{SS} \Rightarrow ()()\underline{S} \Rightarrow ()()()$
 - $S \Rightarrow \underline{SS} \Rightarrow ()\underline{S} \Rightarrow ()\underline{SS} \Rightarrow ()()\underline{S} \Rightarrow ()()()$

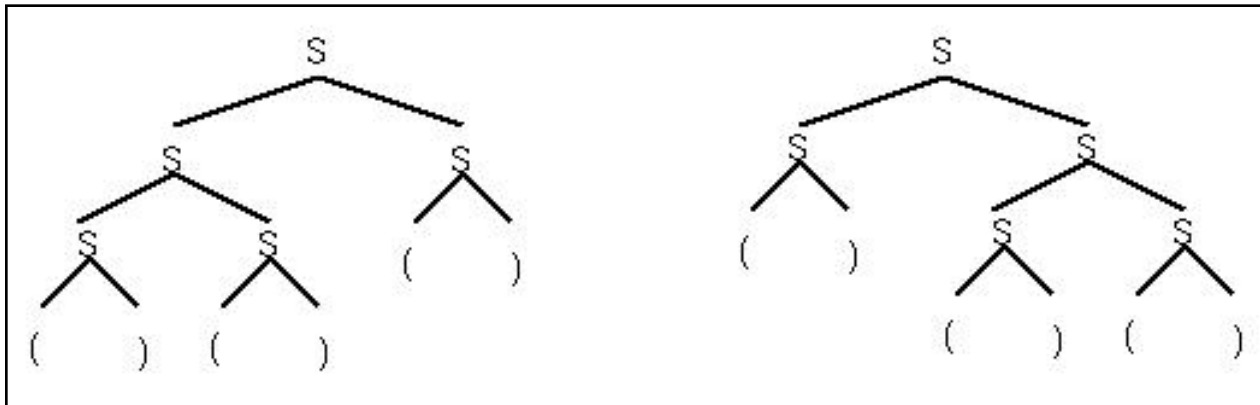

CFGs for Programming Languages

- ▶ Recall that our goal is to describe programming languages with CFGs
- ▶ We had the following example which describes limited arithmetic expressions
$$E \rightarrow a \mid b \mid c \mid E+E \mid E-E \mid E * E \mid (E)$$
- ▶ What's wrong with using this grammar?
 - It's ambiguous!

Example: a-b-c

$E \Rightarrow E-E \Rightarrow a-E \Rightarrow a-E-E \Rightarrow$
 $a-b-E \Rightarrow a-b-c$

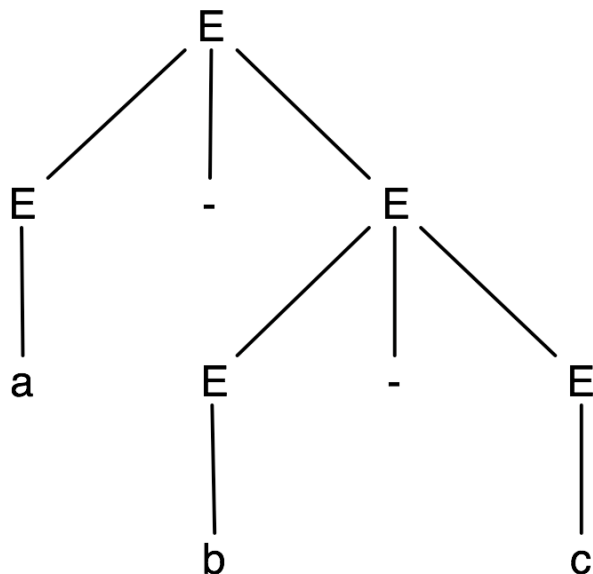

Corresponds to $a-(b-c)$

$E \Rightarrow E-E \Rightarrow E-E-E \Rightarrow$
 $a-E-E \Rightarrow a-b-E \Rightarrow a-b-c$

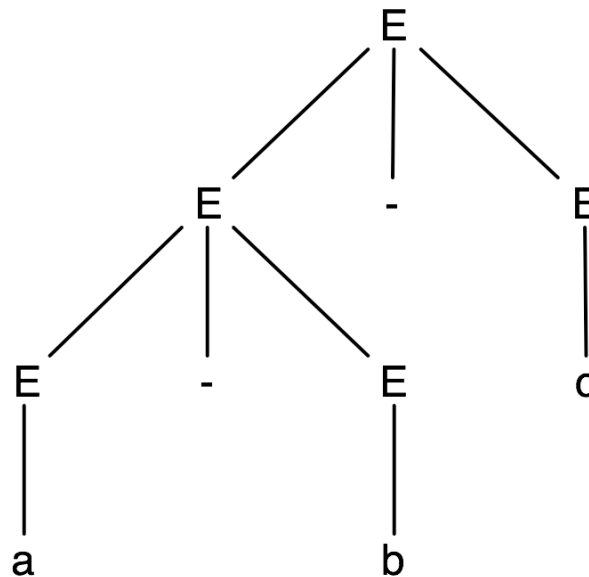

Corresponds to $(a-b)-c$

Example: $a-b^*c$

$E \Rightarrow E-E \Rightarrow a-E \Rightarrow a-E^*E \Rightarrow$
 $a-b^*E \Rightarrow a-b^*c$

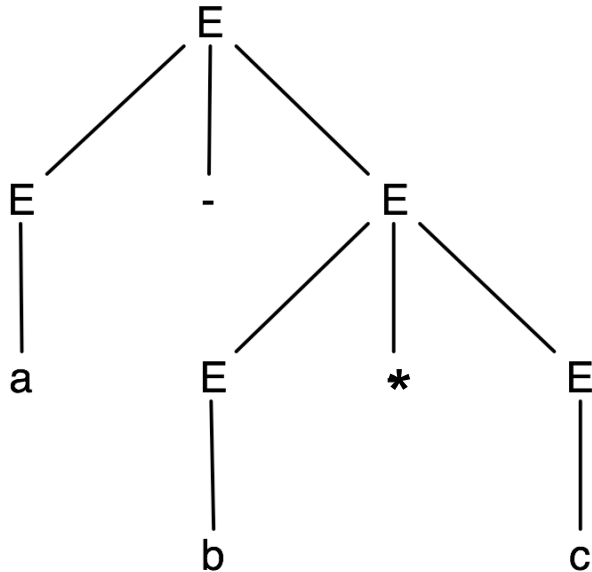

Corresponds to $a-(b^*c)$

$E \Rightarrow E-E \Rightarrow E-E^*E \Rightarrow$
 $a-E^*E \Rightarrow a-b^*E \Rightarrow a-b^*c$

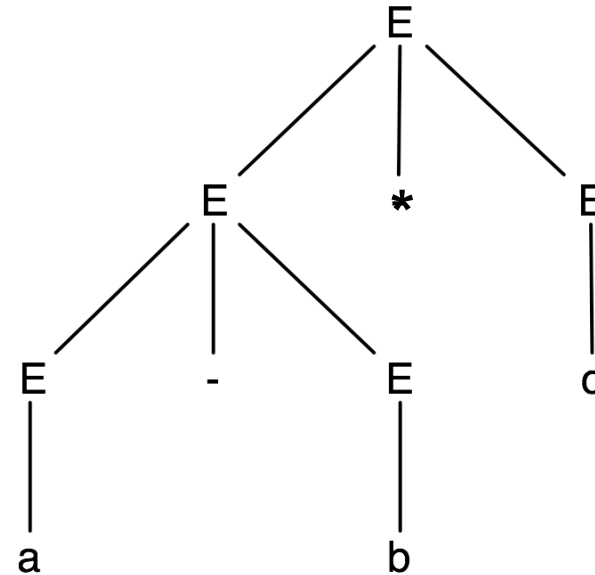

Corresponds to $(a-b)^*c$

Another Example: If-Then-Else

Aka **the dangling else problem**

$\langle \text{stmt} \rangle \rightarrow \langle \text{assignment} \rangle \mid \langle \text{if-stmt} \rangle \mid \dots$

$\langle \text{if-stmt} \rangle \rightarrow \text{if } (\langle \text{expr} \rangle) \langle \text{stmt} \rangle \mid$
 $\quad \text{if } (\langle \text{expr} \rangle) \langle \text{stmt} \rangle \text{ else } \langle \text{stmt} \rangle$

(Recall $\langle \rangle$'s are used to denote nonterminals)

- ▶ Consider the following program fragment

```
if (x > y)
  if (x < z)
    a = 1;
  else a = 2;
```

(Note: Ignore newlines)

Two Parse Trees

```
if (x > y)
    if (x < z)
        a = 1;
    else a = 2;
```

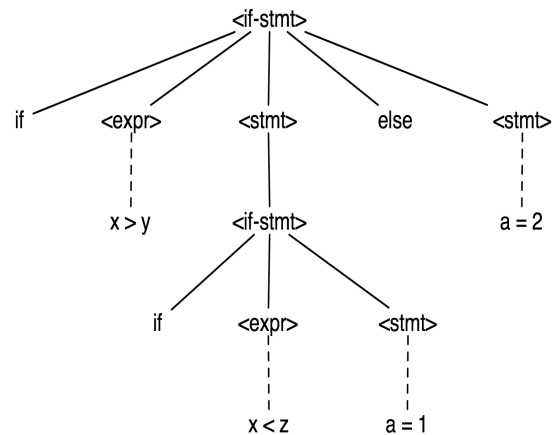
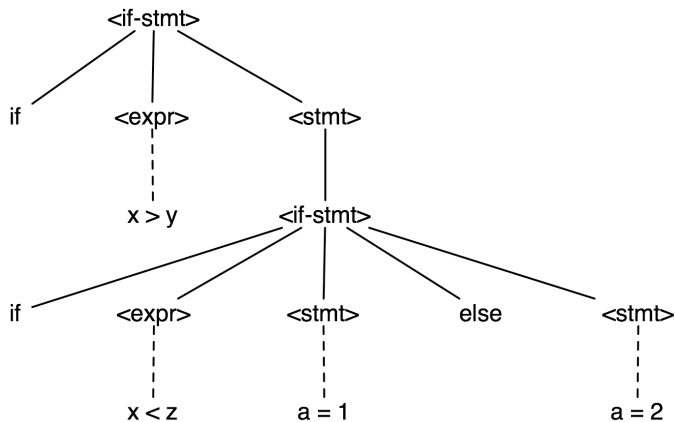

Quiz #5

Which of the following grammars is ambiguous?

A. $S \rightarrow 0SS1 \mid 0S1 \mid \varepsilon$

B. $S \rightarrow A1S1A \mid \varepsilon$

$$A \rightarrow 0$$

C. $S \rightarrow (S, S, S) \mid 1$

D. None of the above.

Quiz #5

Which of the following grammars is ambiguous?

A. $S \rightarrow 0SS1 \mid 0S1 \mid \varepsilon$

B. $S \rightarrow A1S1A \mid \varepsilon$

$A \rightarrow 0$

C. $S \rightarrow (S, S, S) \mid 1$

D. None of the above.

Dealing With Ambiguous Grammars

- ▶ Ambiguity is bad

- Syntax is correct

- But semantics differ depending on choice

- ▶ Different associativity

$(a-b)-c$ vs. $a-(b-c)$

- ▶ Different precedence

$(a-b)*c$ vs. $a-(b*c)$

- ▶ Different control flow

if (if else) vs. if (if) else

- ▶ Two approaches

- Rewrite grammar

- ▶ **Grammars are not unique** – can have multiple grammars for the same language. But result in different parses.

- Use special parsing rules

- ▶ Depending on parsing tool

Fixing the Expression Grammar

- ▶ Require right operand to not be bare expression

$$E \rightarrow E+T \mid E-T \mid E*T \mid T$$

$$T \rightarrow a \mid b \mid c \mid (E)$$

- ▶ Corresponds to **left associativity**
- ▶ Now only one parse tree for **a-b-c**
 - Find derivation

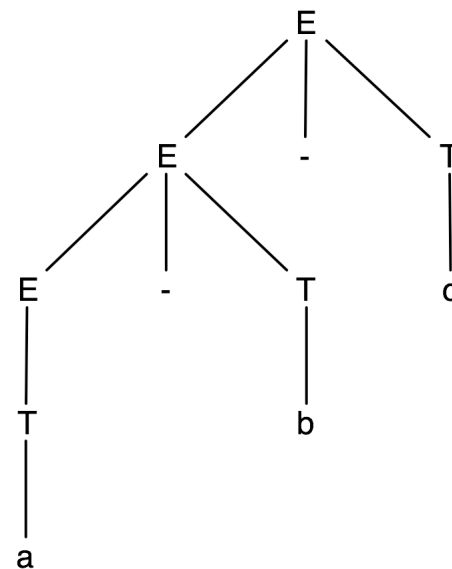

What if we want Right Associativity?

- ▶ Left-recursive productions

- Used for left-associative operators
- Example

$$E \rightarrow E+T \mid E-T \mid E*T \mid T$$
$$T \rightarrow a \mid b \mid c \mid (E)$$

- ▶ Right-recursive productions

- Used for right-associative operators
- Example

$$E \rightarrow T+E \mid T-E \mid T*E \mid T$$
$$T \rightarrow a \mid b \mid c \mid (E)$$

Parse Tree Shape

- ▶ The kind of recursion determines the shape of the parse tree

left
recursion

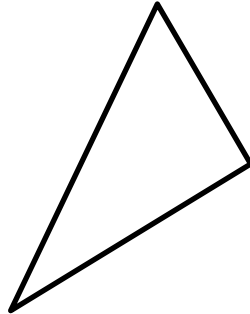

right recursion

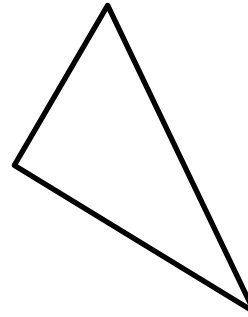

A Different Problem

- ▶ How about the string $a+b*c$?

$$E \rightarrow E+T \mid E-T \mid E*T \mid T$$

$$T \rightarrow a \mid b \mid c \mid (E)$$

- ▶ Doesn't have correct precedence for $*$

- When a nonterminal has productions for several operators, they effectively have the same precedence

- ▶ Solution – Introduce **new** nonterminals

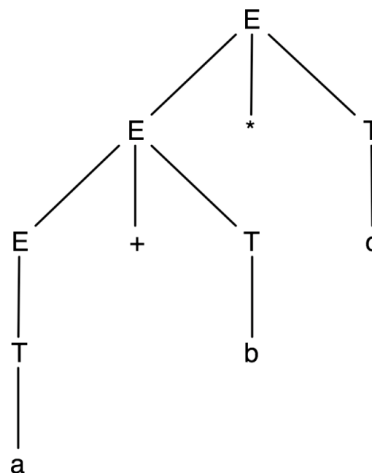

Final Expression Grammar

$E \rightarrow E+T \mid E-T \mid T$ lowest precedence operators
 $T \rightarrow T*P \mid P$ higher precedence
 $P \rightarrow a \mid b \mid c \mid (E)$ highest precedence (parentheses)

- ▶ Controlling precedence of operators
 - Introduce new nonterminals
 - Precedence increases closer to operands
- ▶ Controlling associativity of operators
 - Introduce new nonterminals
 - Assign associativity based on production form
 - $E \rightarrow E+T$ (left associative) vs. $E \rightarrow T+E$ (right associative)
 - But parsing method might limit form of rules

Conclusion

- ▶ Context Free Grammars (CFGs) can describe programming language syntax
 - They are a kind of formal language that is more powerful than regular expressions
- ▶ CFGs can also be used as the basis for programming language parsers (details later)
 - But the grammar should not be ambiguous
 - May need to change more natural grammar to make it so
 - Parsing often aims to produce abstract syntax trees
 - Data structure that records the key elements of program